



High Performance Standard AC Drive

LSLV iS7

0.75~75kW(1~125HP) 3-Phase 200~230V
0.75~375kW(1~700HP) 3-Phase 380~480V
IP54 0.75kW~22kW(1~40HP) 3-Phase 200~230V
IP54 0.75kW~22kW(1~40HP) 3-Phase 380~480V



LSIS

iS7 generates a more powerful performance through its superior V/F control, V/F PG, slip compensation, and sensorless vector control. The iS7 focuses on a user-friendly interface and environment-friendly features including a wide graphic LCD keypad, user & macro group support, electro-thermal functions for motor protection, and protection for input/output phase loss.



The iS7 sets the world standard for drives (VFDs) because of its features that meet all of your needs in AC drives.

The iS7 offers powerful performance, flexibility through diverse options, and a more convenient and user-friendly interface.

The iS7 offers more than you can imagine.



ISO14001, ISO9001



iS7 is dependable because it has high performance and reliability.



iS7 Feature | **Reliability & High Performance**

Reliability

- ▶ **Powerful electric current type sensorless vector control**
Our iS7 technology includes a competitive and strong low-speed torque control and a speed-precision-driven vector algorithm.
 - Speed control range 100:1
 - Extremely low torque control capability: 0.1Hz/150% real torque
 - Max. torque control capability within the restoration range

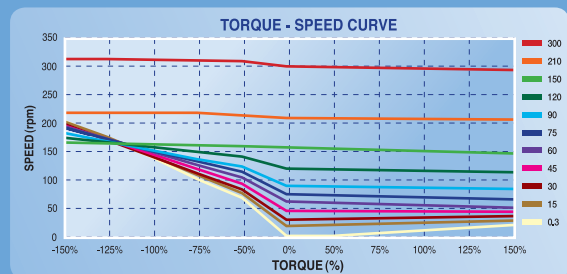

High Performance

➤ **Sensored vector realizing precise speed/torque control**

In the entire speed range including zero speed, powerful torque (more than 250%) performance is materialized through receiving Max. 200kHz frequency pulse via encoder-dedicated board.

- Speed control range 1000:1
- Instant Max. torque control capability 250%
- 50Hz speed control response

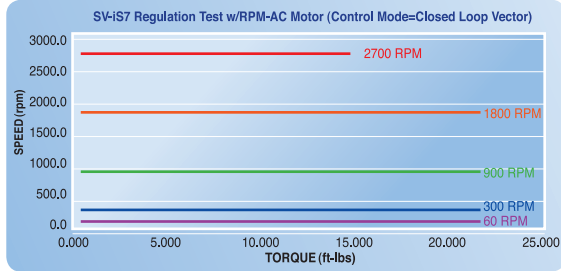

➤ **Ride-through (LV trip delay) for sudden power loss**

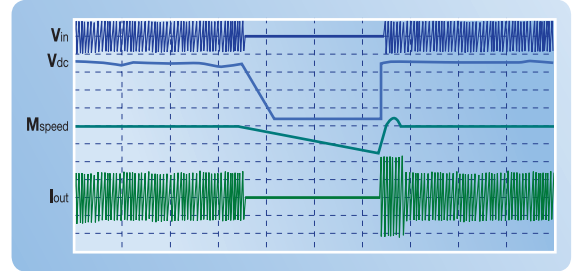

Powerful Performance

V/F control, V/F PG, slip compensation, sensorless vector control

➤ **Automatic torque balance droop control**

Droop control algorithm adjusts changeable torque driven by speed. This algorithm is easily applicable to open loop linking driving and load sharing driving.

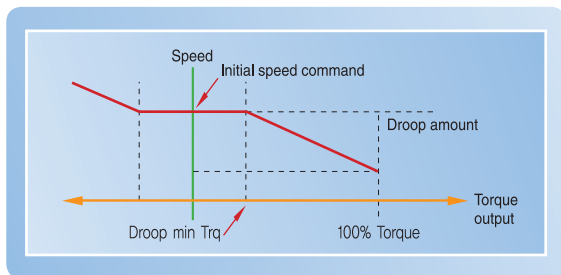

➤ **Kinetic Energy Buffering (KEB) for a stable system stop in case of power loss or failure**

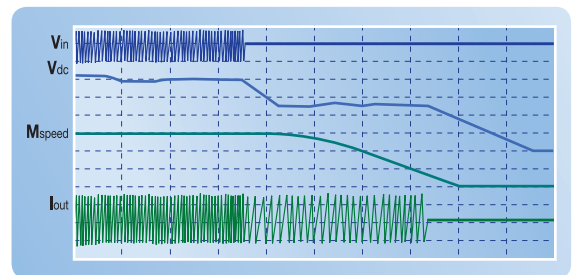

➤ **Easy start parameter setting**

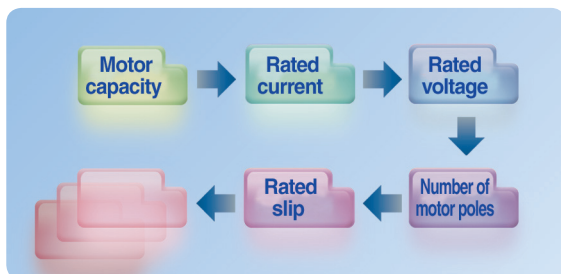

➤ **Flying start function**

Drive capable of quick reliable smooth restarts into bi-directional rotating loads.

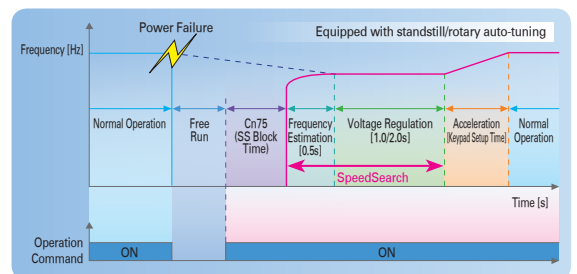

➤ **Power and flux braking for maximum deceleration**

➤ **Safety Option**

The Safety input function meets EN ISO 13849-1 PLd and EN 61508 SIL2 (EN60204-1, stop category 0).

This feature is standard and enables compliance with current safety standards.

iS7 is flexible because it is easily expandable.



iS7 Feature | **Flexibility & Expansion**

Flexibility Expansion

- * 1) Extension I/O-2 is only dedicated for WEB(Winder) customized models.
- * 2) In order to use position control and synchronous options, customer have to purchase that customized product or to install customized main software.
- * 3) Below 22kW : Default Built-in Basic I/O
Above 30kW : Default Built-in Isolation I/O
- * More information about the options, refer to the 23Page.

Conduit kit option

- Acquired UL open type & enclosed type1 certification
- * UL open type is offered as default
- * UL enclosed type1 needs conduit kit(option) installation
- 0.75~75kW (1~100HP)



Flange Option

- The heat sink can be mounted outside of the panel in case the space is limited.
- 0.75~75kW (1~100HP)



User-Friendly Options

Diverse communication options, expansion I/O options, PLC options, encoder options, IP54 enclosure options

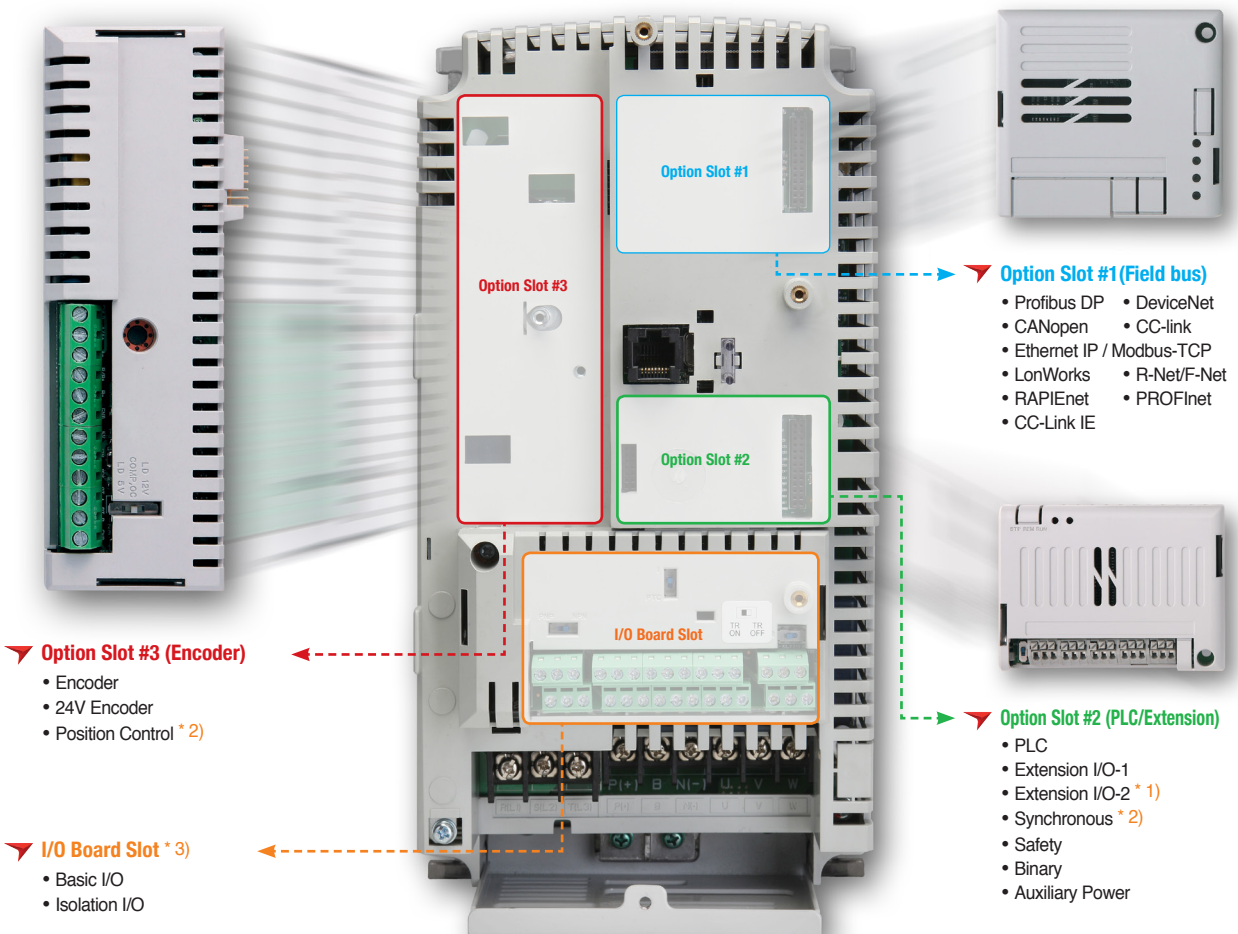

iS7 is convenient because it has a user friendly interface.



iS7 Feature | Convenience & Environment

Convenience Environment

▶ EMC filter (in conformity with EN61800-3) built-in for protection from excessive electronic distortion

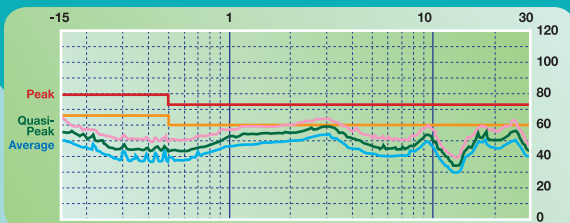
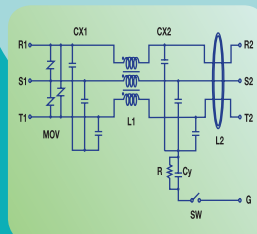
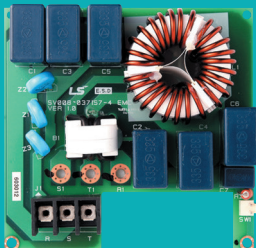

▶ DC reactor built-in for harmonic reduction and power factor improvement

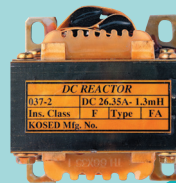

Overloading rate	110% (VT rated standard)
THD	18 ~ 37%
power factor	94 ~ 96%
IP Level	IP21
Insulation Class	155°C (300°F)

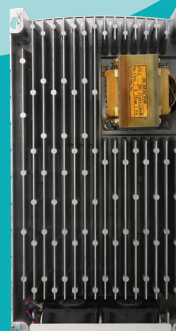

Input current and THD analysis

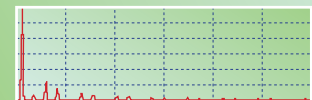
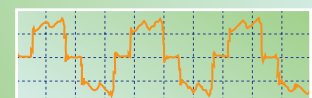

THD : 29.3% PF : 95.9%

➤ **Widened graphic LCD keypad**

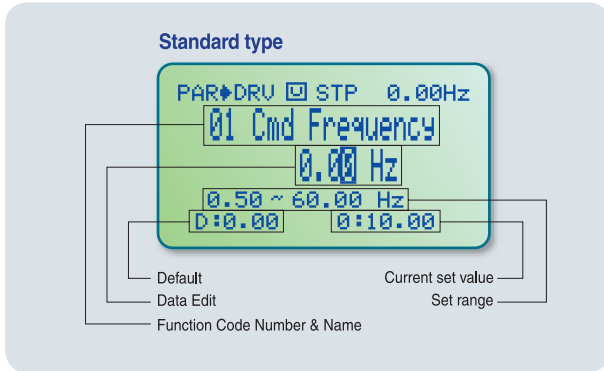

➤ **Multi-language support (5 languages)**

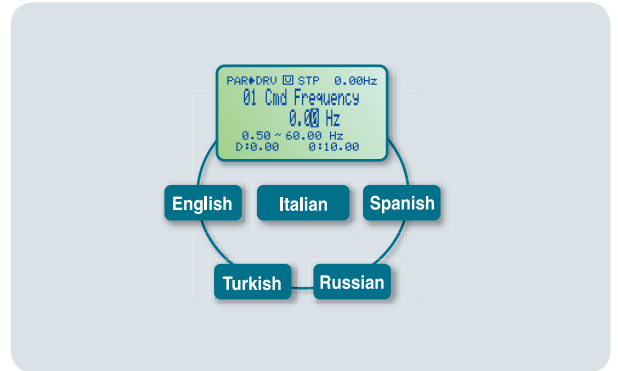

Convenience through User-friendly Interface

➤ **Efficient architecture of 5-mode 15-parameter groups**

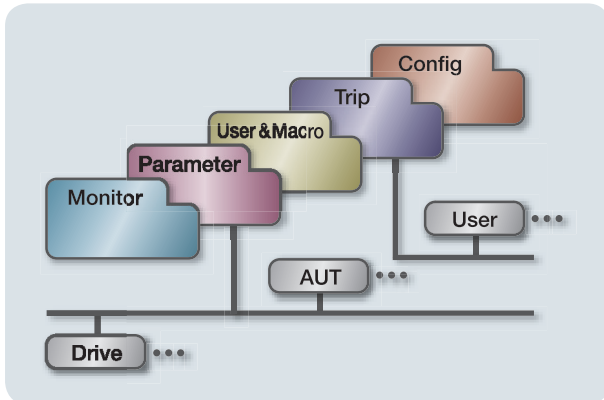

➤ **User & macro group support**

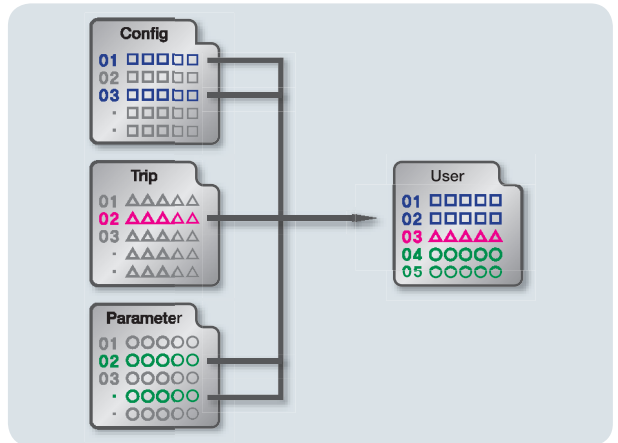

➤ **Multi-function key**

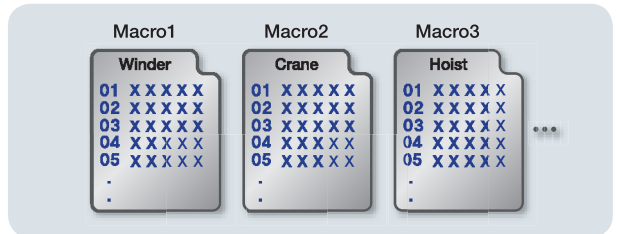
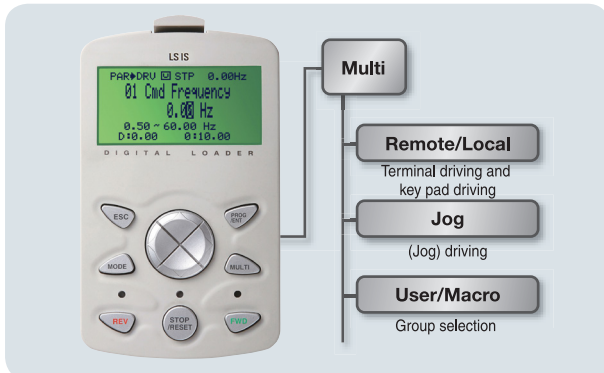

➤ **Protective functions dedicated motor control**

iS7

iS7 is competitive because it is applicable to various industrial fields.

Application

STARVERT iS7 Feature | **Variety Application**

Variety

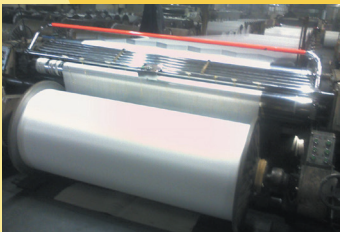

Warping/Beaming Machine

- Encoder feedback
- Tension control with built-in PID
- (Winding)
- Jog operation
- Anti-rollback



Laminating Machine

- Tension control with dancer feedback
- Diameter estimator winding
- Positive/negative taper
- Constant linear speed control



Wire Drawing Machine

- Capstan operation with sensorless
- Tension control with dancer feedback
- Diameter estimator winding
- Skip function
- Constant linear speed control



Tire Line

- Tag time reduction (Fast response time)
- Tension control with draw function
- Jog operation
- C3 conformal coating
- IP54 enclosure



Elevator

- Elevator optimized brake control
- Zero speed control (with encoder)
- Over speed check function
- Elevator master function (with PLC option)
- Ideal S curve (for comfortable driving)



Lift

- Joystick function
- Soft start & stop
- Over speed check function
- Stationary torque holding
- Dual motor control

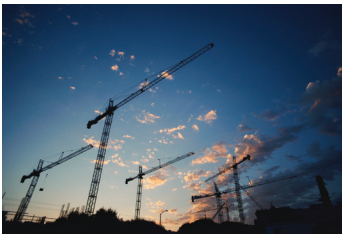
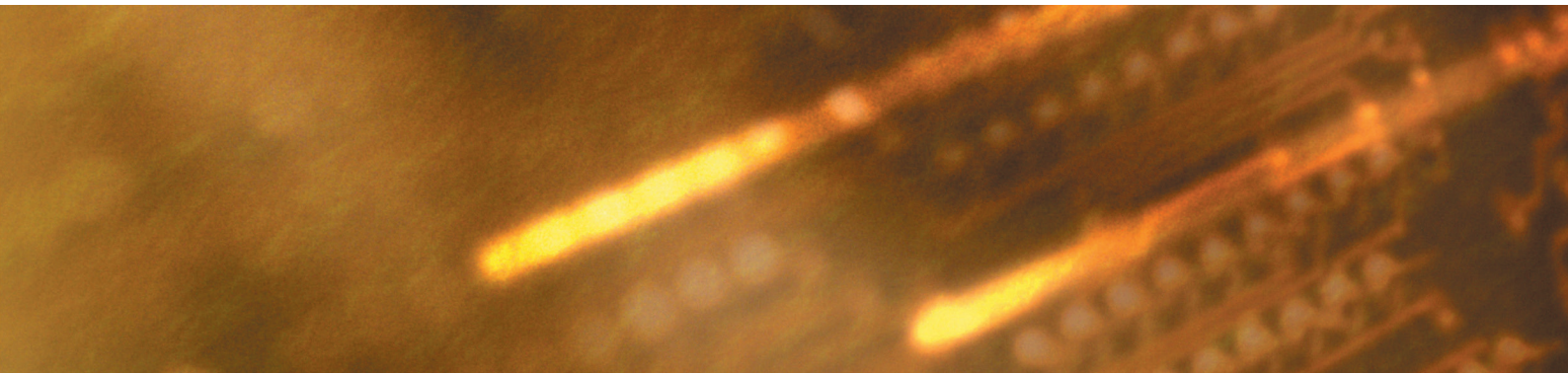

Crane/Hoist

- Sensorless control
- Weight load brake control function
- Optimized load balancing
- Customized DB unit



Parking Facility

- Low speed torque control
- Powerful starting torque
- 2nd source for Vertical and horizontal transverse sequential motor control



Automated Warehouse

- Smooth deceleration and precise target layer stops with powerful torque
- Real-time monitoring with Driveview7



Press Machine

- Peak current limit
- Inhibit regenerative operation



Washing Machine/extractor

- Powerful laundry property with strong torque
- Effective deceleration with power braking & flux braking
- High speed operation with optimized algorithm



Air Compressor

- Optimized operation with enhanced PID algorithm
- Energy saving with sleep & wake up function
- Soft start/stop function



Model and Type

Motor Rating	200V Class		400V Class	
	VT(Normal Duty)	CT(Heavy Duty)	VT(Normal Duty)	CT(Heavy Duty)
0.75kW	SV0008 iS7-2NO(F)(D)	SV0008 iS7-2NO(F)(D)	SV0008 iS7-4NO(F)(D)	SV0008 iS7-4NO(F)(D)
1.5kW	SV0008 iS7-2NO(F)(D)	SV0015 iS7-2NO(F)(D)	SV0008 iS7-4NO(F)(D)	SV0015 iS7-4NO(F)(D)
2.2kW	SV0015 iS7-2NO(F)(D)	SV0022 iS7-2NO(F)(D)	SV0015 iS7-4NO(F)(D)	SV0022 iS7-4NO(F)(D)
3.7kW	SV0022 iS7-2NO(F)(D)	SV0037 iS7-2NO(F)(D)	SV0022 iS7-4NO(F)(D)	SV0037 iS7-4NO(F)(D)
5.5kW	SV0037 iS7-2NO(F)(D)	SV0055 iS7-2NO(F)(D)	SV0037 iS7-4NO(F)(D)	SV0055 iS7-4NO(F)(D)
7.5kW	SV0055 iS7-2NO(F)(D)	SV0075 iS7-2NO(F)(D)	SV0055 iS7-4NO(F)(D)	SV0075 iS7-4NO(F)(D)
11kW	SV0075 iS7-2NO(F)(D)	SV0110 iS7-2NO(F)(D)	SV0075 iS7-4NO(F)(D)	SV0110 iS7-4NO(F)(D)
15kW	SV0110 iS7-2NO(F)(D)	SV0150 iS7-2NO(F)(D)	SV0110 iS7-4NO(F)(D)	SV0150 iS7-4NO(F)(D)
18.5kW	SV0150 iS7-2NO(F)(D)	SV0185 iS7-2NO(F)(D)	SV0150 iS7-4NO(F)(D)	SV0185 iS7-4NO(F)(D)
22kW	SV0185 iS7-2NO(F)(D)	SV0220 iS7-2NO(F)(D)	SV0185 iS7-4NO(F)(D)	SV0220 iS7-4NO(F)(D)
30kW	SV0220 iS7-2NO(F)(D)	SV0300 iS7-2SO	SV0220 iS7-4NO(F)(D)	SV0300 iS7-4NO(D)
37kW	SV0300 iS7-2SO	SV0370 iS7-2SO	SV0300 iS7-4NO(D)	SV0370 iS7-4NO(D)
45kW	SV0370 iS7-2SO	SV0450 iS7-2SO	SV0370 iS7-4NO(D)	SV0450 iS7-4NO(D)
55kW	SV0450 iS7-2SO	SV0550 iS7-2SO	SV0450 iS7-4NO(D)	SV0550 iS7-4NO(D)
75kW	SV0550 iS7-2SO	SV0750 iS7-2SO	SV0550 iS7-4NO(D)	SV0750 iS7-4NO(D)
90kW	SV0750 iS7-2SO		SV0750 iS7-4NO(D)	SV0900 iS7-4SOD
110kW			SV0900 iS7-4SOD	SV1100 iS7-4SOD
132kW			SV1100 iS7-4SOD	SV1320 iS7-4SOD
160kW			SV1320 iS7-4SOD	SV1600 iS7-4SOD
185kW			SV1600 iS7-4SOD	SV1850 iS7-4SOD
220kW			SV1850 iS7-4SOD	SV2200 iS7-4SOD
280kW			SV2200 iS7-4SOD	SV2800 iS7-4SO
315kW			SV2800 iS7-4SO	SV3150 iS7-4SO
375kW			SV3150 iS7-4SO	SV3750 iS7-4SO
450kW			SV3750 iS7-4SO	

- ※ (F) : Built-in EMC(F) or Non-EMC(Blank) selectable
- ※ (D) : Built-in DCR(D) or Non-Reactor(Blank) selectable
- ※ Non DCR products are provided warranty service when used in CT(Constant Torque) load rating only.
- ※ Please request LSIS sale person for UL Type12(IP54) / Web customized product.

Customization (W: Web control, S: Synchronization, V: Vessel, E: High efficiency)

SV	0008	iS7	2	N	O	F	D	W		
LS Drive Starvert Series	Capacity of Applied Motor		Input Voltage	Keypad	UL	Filter	DC Reactor	Customized Product		
	0008	0.75 [kW]						2	3-Phase	N
	0015	1.5 [kW]	2	200~230[V]	S	GLCD (Graphic Loader)	Blank	NON	S	Synchronous
	0022	2.2 [kW]	4	3-Phase			D	DC Reactor	T	Safety ⁵⁾
	0037	3.7 [kW]		380~480[V]			R	DB Resistor ³⁾ (Inner Mounted)	V ⁴⁾	Marine
	0055	5.5 [kW]								
	0075	7.5 [kW]								
	0110	11 [kW]								
	0150	15 [kW]								
	0185	18.5 [kW]								
	0220	22 [kW]								
	0300	30 [kW]								
	0370	37 [kW]								
	0450	45 [kW]								
	0550	55 [kW]								
	0750	75 [kW]								
	0900	90 [kW]								
	1100	110 [kW]								
	1320	132 [kW]								
	1600	160 [kW]								
1850	185 [kW]									
2200	220 [kW]									
2800	280 [kW]									
3150	315 [kW]									
3750	375 [kW]									

*1) For 0.75~75kW range, Enclosed Type 1 can be satisfied if conduit option installed.

*2) Enclosed UL Type 1,2 is available from 0.75 to 22kW.

*3) Built-in DB Resistor option is available only for Web version product from 0.75kW to 3.7kW.

DB Resistor of IS7 Product is the option of WEB product. Applicable capacity is from 0.75 to 375 kW of IS7 Products.

*4) More information about Marine Certification, refer to the 25 Page.

*5) For 0.75~160kW, Safety option is provided as built-in form from manufacturer.

For 185~375kW, customer can purchase Safety option and install on product by himself.

Specification

Rated Input and Output: Input voltage of 200V class (0.75~22kW)

Type: SV □□□□ iS7-2 □			0008	0015	0022	0037	0055	0075	0110	0150	0185	0220	
Motor Applied ^{*1)}	VT	[HP]	2	3	5	7.5	10	15	20	25	30	40	
		[kW]	1.5	2.2	3.7	5.5	7.5	11	15	18.5	22	30	
	CT	[HP]	1	2	3	5	7.5	10	15	20	25	30	
		[kW]	0.75	1.5	2.2	3.7	5.5	7.5	11	15	18.5	22	
Rated Output	Rated Capacity [kVA] ^{*2)}		1.9	3.0	4.5	6.1	9.1	12.2	17.5	22.9	28.2	33.5	
	Rated Current [A] ^{*3)}	CT	5	8	12	16	24	32	46	60	74	88	
		VT	8	12	16	24	32	46	60	74	88	124	
	Output Frequency [Hz]		0 ~ 400 [Hz] ^{*4)}										
Output Voltage [V]		3-phase 200 ~ 230V ^{*5)} (Sensorless-1 : 0~300Hz, Sensorless-2, Vector : 0.1~120Hz)											
Rated Input	Available Voltage [V]		3-phase 200 ~ 230 VAC (-15% ~ +10%)										
	Frequency [Hz]		50 ~ 60 [Hz] (±5%)										
	Rated Current [A]	CT	4.3	6.9	11.2	14.9	22.1	28.6	44.3	55.9	70.8	85.3	
VT		6.8	10.6	14.9	21.3	28.6	41.2	54.7	69.7	82.9	116.1		

2.1.2 Rated Input and Output: Input voltage of 200V class (30~75kw)

Type: SV □□□□ iS7-2 □			0300	0370	0450	0550	0750	-	-	-	-	-	
Motor Applied ^{*1)}	VT	[HP]	50	60	75	100	125	-	-	-	-	-	
		[kW]	37	45	55	75	90	-	-	-	-	-	
	CT	[HP]	40	50	60	75	100	-	-	-	-	-	
		[kW]	30	37	45	55	75	-	-	-	-	-	
Rated Output	Rated Capacity [kVA] ^{*2)}		46	57	69	84	116	-	-	-	-	-	
	Rated Current [A] ^{*3)}	CT	116	146	180	220	288	-	-	-	-	-	
		VT	146	180	220	288	345	-	-	-	-	-	
	Output Frequency [Hz]		0 ~ 400 [Hz] ^{*4)} (Sensorless -1: 0 ~ 300Hz, Sensorless -2, Vector. 0.1~120Hz)										
Output Voltage [V]		3-phase 200 ~ 230V ^{*5)}											
Rated Input	Available Voltage [V]		3-phase 200 ~ 230 VAC (-15% ~ +10%)										
	Input Frequency		50 ~ 60 [Hz] (±5%)										
	Rated Current [A]	CT	121	154	191	233	305	-	-	-	-	-	
VT		152	190	231	302	362	-	-	-	-	-		

Rated Input and Output: Input voltage of 400V class (0.75~22kW)

Type: SV □□□□ iS7-4 □			0008	0015	0022	0037	0055	0075	0110	0150	0185	0220	
Motor Applied ^{*1)}	VT	[HP]	2	3	5	7.5	10	15	20	25	30	40	
		[kW]	1.5	2.2	3.7	5.5	7.5	11	15	18.5	22	30	
	CT	[HP]	1	2	3	5	7.5	10	15	20	25	30	
		[kW]	0.75	1.5	2.2	3.7	5.5	7.5	11	15	18.5	22	
Rated Output	Rated Capacity [kVA] ^{*2)}		1.9	3.0	4.5	6.1	9.1	12.2	18.3	22.9	29.7	34.3	
	Rated Current [A] ^{*3)}	CT	2.5	4	6	8	12	16	24	30	39	45	
		VT	4	6	8	12	16	24	30	39	45	61	
	Output Frequency [Hz]		0 ~ 400 [Hz] ^{*4)}										
Output Voltage [V]		3-phase 380 ~ 480V ^{*5)} (Sensorless-1 : 0~300Hz, Sensorless-2, Vector : 0.1~120Hz)											
Rated Input	Available Voltage [V]		3-phase 380 ~ 480 VAC (-15% ~ +10%)										
	Frequency		50 ~ 60 [Hz] (±5%)										
	Rated Current [A]	CT	2.2	3.6	5.5	7.5	11.0	14.4	22.0	26.6	35.6	41.6	
VT		3.7	5.7	7.7	11.1	14.7	21.9	26.4	35.5	41.1	55.7		

^{*1)} Motor Applied indicates the maximum capacity applied to use of a standard 4 pole standard motor.

^{*2)} Rated Capacity: the input capacity of a 200V class is based on 220V and that of a 400V class is based on 440V. The current rating is based on CT current.

^{*3)} The output of rated current is limited according to the setting of the carrier frequency (CON-04).

^{*4)} You can set the frequency at up to 300Hz by selecting 3, 4 Sensorless-1, Sensorless-2 as the control mode (DRV-09 Control Mode).

^{*5)} The maximum output voltage does not go over the supplied power voltage. You can select the output voltage as you want below the supplied power voltage.

* Non DCR products are provided warranty service when used in CT (Heavy duty) load rating only.



Specifications

Rated Input and Output: Input voltage of 400V class (30~375kW)

Type: SV □□□□IS7-4 □		0300	0370	0450	0550	0750	0900	1100	1320	1600	1850	2200	2850	3150	3750	
Motor Applied *1)	VT	[HP]	50	60	75	100	125	150	200	250	300	350	400	500	600	700
		[kW]	37	45	55	75	90	110	132	160	185	220	280	315	375	450
	CT	[HP]	40	50	60	75	100	125	150	200	250	300	350	400	500	600
		[kW]	30	37	45	55	75	90	110	132	160	185	220	280	315	375
Rated Output	Rated Capacity [kVA] *2)		46	57	69	84	116	139	170	201	248	286	329	416	467	557
	Rated Current [A] *3)	CT	61	75	91	110	152	183	223	264	325	370	432	547	613	731
		VT	75	91	110	152	183	223	264	325	370	432	547	613	731	877
	Output Frequency [Hz]		0 ~ 400 [Hz] (Sensorless-1: 0 ~ 300Hz, Sensorless-2, Vector: 0 ~ 120Hz) *4)													
Output Voltage [V]		3-phase 380 ~ 480V *5)														
Rated Input	Available Voltage [V]		3-phase 380 ~ 480 VAC (-15% ~ +10%)													
	Frequency [Hz]		50 ~ 60 [Hz] (±5%)													
	Rated Current [A]	CT	55.5	67.9	82.4	102.6	143.4	174.7	213.5	255.6	316.3	404	466	605	674	798
VT		67.5	81.7	101.8	143.6	173.4	212.9	254.2	315.3	359.3	463	590	673	796	948	

*1) Motor Applied indicates the maximum capacity applied of a standard 4 pole OTIS-LG motor.

*2) Rated Capacity: the input capacity of a 200V class is based on 220V and that of a 400V class is based on 440V. The current rating is based on CT current.

*3) The output of rated current is limited according to the setting of the carrier frequency (CON-04).

*4) In case of Sensorless-1, you can set the frequency at up to 300Hz by selecting 3, 4 as the control mode (DRV-09 Control Mode).

In case of Sensorless-2, you can set the frequency at up to 120Hz by selecting 3, 4 as the control mode (DRV-09 Control Mode).

*5) The maximum output voltage does not go up over the supplied power voltage. You can select the output voltage as you want below the supplied power voltage.

* Non DCR products are provided warranty service when used in CT (Heavy duty) load rating only.

Control

Control Method	V/F control, V/F PG, slip compensation, sensorless vector-1, sensorless vector-2, vector control
Frequency Setting Resolution	Digital command: 0.01Hz Analog command: 0.06Hz (maximum frequency: 60Hz)
Frequency Tolerance	Digital command operation: 0.01% of the maximum frequency Analog command operation: 0.1% of the maximum frequency
V/F Pattern	Linear, double reduction, user V/F
Overload Capacity	CT current rating: 150% for 1 minute, VT current rating: 110% for 1 minute
Torque Boost	Manual torque boost, automatic torque boost

Specifications

Specifications

Operating Method		Selectable among keypad/terminal block/communication operation	
Frequency Setting		Analog: 0 ~ 10[V], -10 ~ 10[V], 0 ~ 20[mA] Digital: keypad	
Operating Function		PID control, up-down operation, 3-wire operation, DC brake, frequency limit, frequency jump, second function, slip compensation, reverse rotation prevention, auto restart, drive by-pass, auto tune flying start, energy buffering, power braking, flux braking, leakage current reduction, MMC, easy start	
Input	Multi-function terminal (8 points) P1 ~ P8 ^{*1)}	NPN (Sink)/PNP (Source) selectable	
		Function: forward operation; reverse operation; reset; external trip; emergency stop; jog operation; sequential frequency-high; medium and low; multi-level acceleration and deceleration-high; medium and low; D.C. control during stop; selection of a second motor; frequency increase; frequency decrease; 3-wire operation; change to general operation during PID operation; main body operation during option operation; analog command frequency fixation; acceleration and deceleration stop selectable	
Output	Multi-function open collector terminal	Drive fault output	Below DC 46V 100mA
	Multi-function relay terminal		Below (N.O., N.C.) AC250V 1A, Below DC 30V 1A
	Analog output	0 ~ 10 Vdc (below 20mA): selectable from frequency, current, voltage, direct current voltage	

*1) The Functions for Multi-function terminal available according to IN-65~72 parameter setting of IN Group.

Protective Functions

Trip	Over voltage, low voltage, over current, over current detection, drive overheat, motor thermal protection, phase loss protection, overload protection, communication error, frequency command loss, hardware failure, cooling fan failure, pre-PID failure, no motor trip, external brake trip. Safety function, etc.
Alarm	Stall prevention, overload, diminished load, encoder error, fan failure, keypad command loss, speed command loss.
Instantaneous Interruption ^{*2)}	Below CT class 15 msec (VT class 8 msec): operation continues (within rated input voltage, rated output) Over CT class 15 msec (VT class 8 msec): automatic restart

*2) Operation at the CT (Heavy Duty) current rating

Structure and Use Environment

Cooling Method	Forced air blast cooling: 0.75 ~ 15kW (200/400V class), 22kW (400V class) Inhalation cooling: 22 ~ 75kW (200V class), 30~375kW (400V class)
Protection Structure	0.75~22kW(200V), 0.75~75kW(400V): Open type IP 21(default), UL enclosed type 1(Option) ^{*3)} 30 ~ 75kW(200V), 90~375kW(400V): Open type IP 00 (default), UL enclosed type 1 (Option) ^{*3)} 0.75~22kW-2/4 and etc: Enclosed IP54 type, UL enclosed type 12
Surrounding Temperature	CT (Heavy Duty) load: -10 ~ 50°C, (14 ~ 122°F) without ice or frost VT (Normal Duty) load: -10~ 40°C (14 ~ 104°F) without ice or frost (It is recommended that you use less than 80% load when you use VT load at 50°C (122°F)) IP54 product: -10~40°C (14~122°F) without ice or frost
Preservation Temperature	-20 ~ 65°C (-4 ~ 149°F)
Surrounding Humidity	Below 95% RH of relative humidity (with no dew formation)
Altitude, Vibration	Below 1,000m (From 1000 to 4000m, the rated input voltage and rated output current of the drive must be derated by 1% for every 100m.), below 5.9m/sec 2 (19.36 ft/sec 2, 0.6G)
Environment	There should be no corrosive gas, flammable gas, oil mist or dust. Pollution Degree 2 Environment
Conformal Coating	To meet the below IEC standard In the harsh operating environment and to enhance PCB Ass'y life cycle IEC 60721-3-3(3C2) / IEC 60068-2-43 / IEC 60068-2-60

*3) UL Enclosed type 1 with conduit box installed. (30~75kW(200V) conduit box has been installed, is Open type IP 20)



Wiring

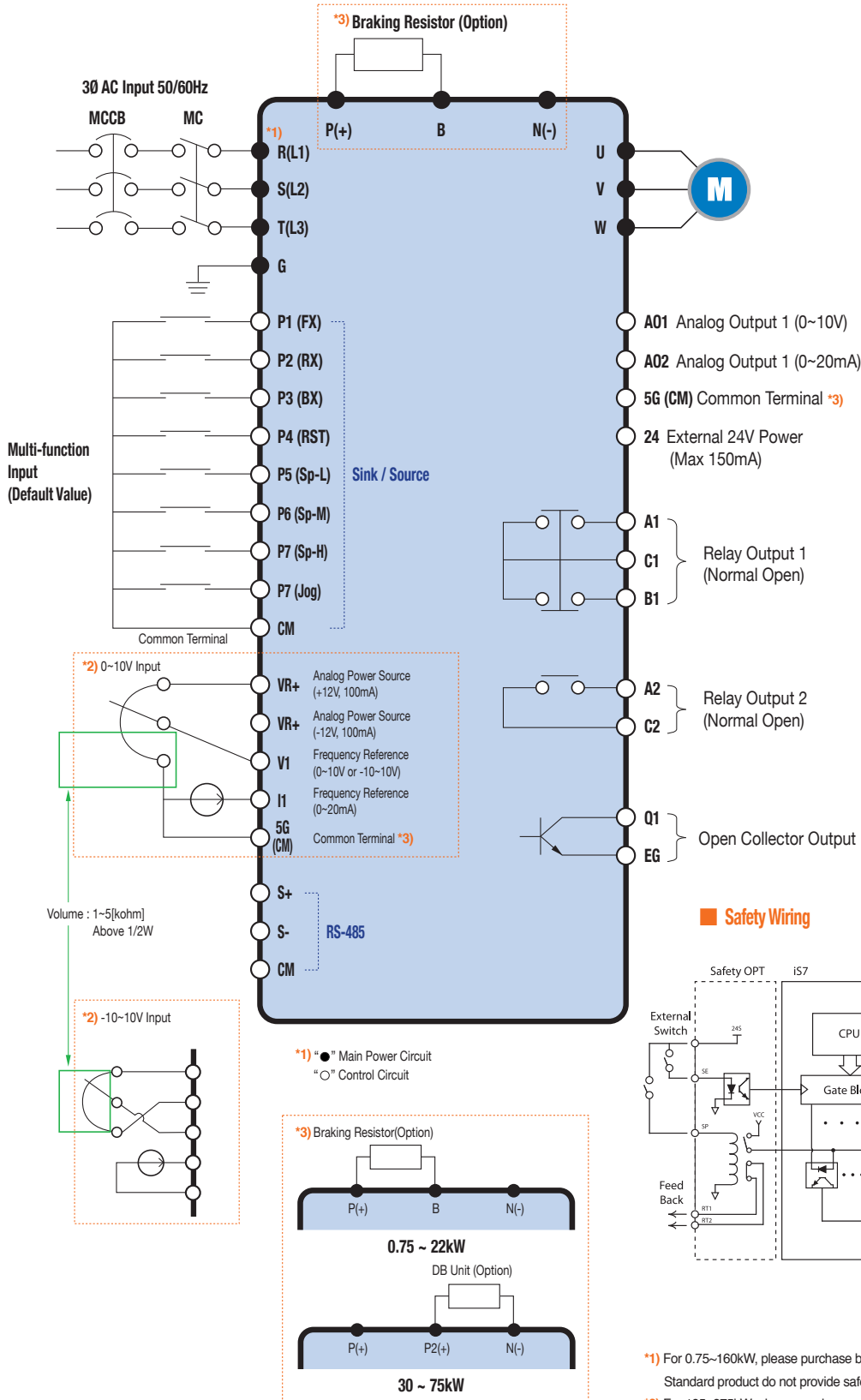

Safety Wiring

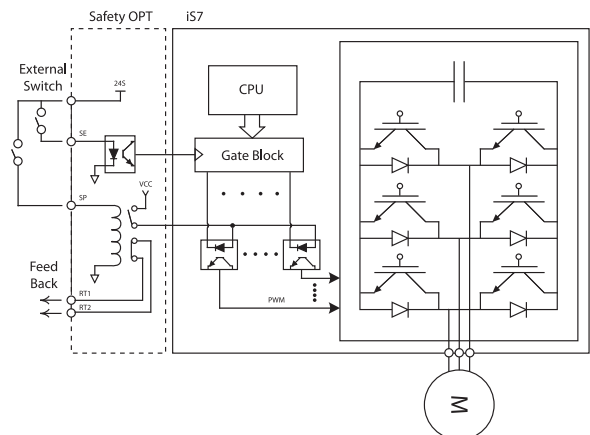

- *1) For 0.75~160kW, please purchase built-in safety option products. Standard product do not provide safety option.
- *2) For 185~375kW, please purchase safety option separately and apply for standard products.
- *3) For 0.75~22kW, please connect to 5G, for 30~375kW, please connect to CM

Wiring

0.75~22kW (Basic I/O)

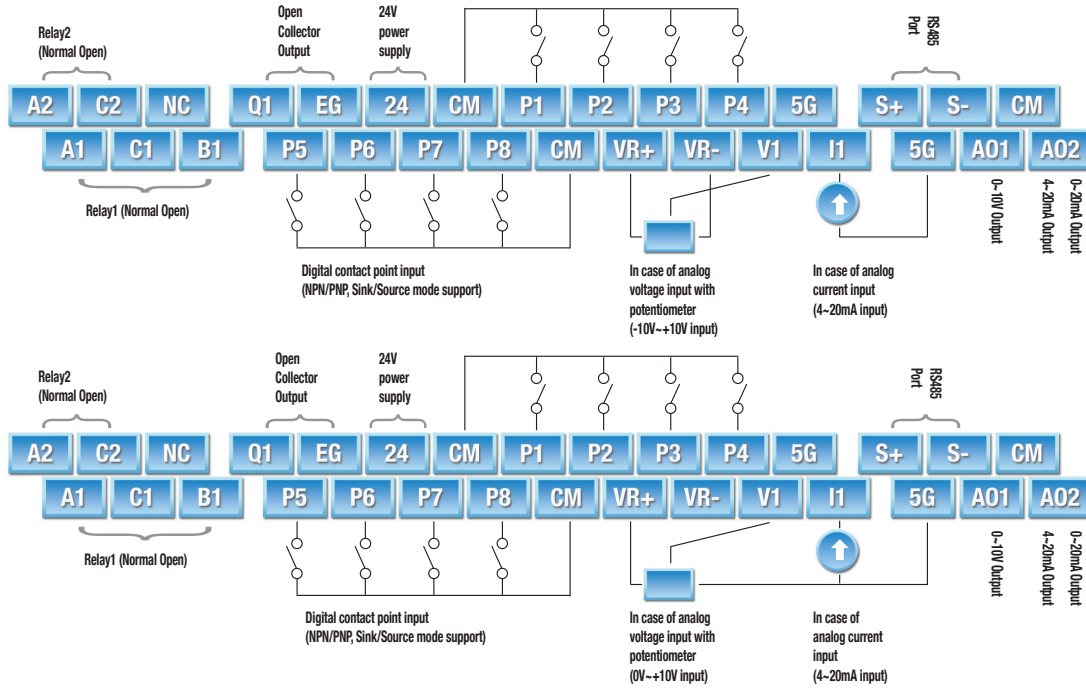

TR terminal located on the above the right side of terminal block is for the terminal resistor of RS485 communication(120Ω)

We recommend the potentiometer for 1/2W, 1kΩ.

* Description of TR terminal and variable resistance are same as those of insulated I/O.

30~375kW (Insulated I/O)

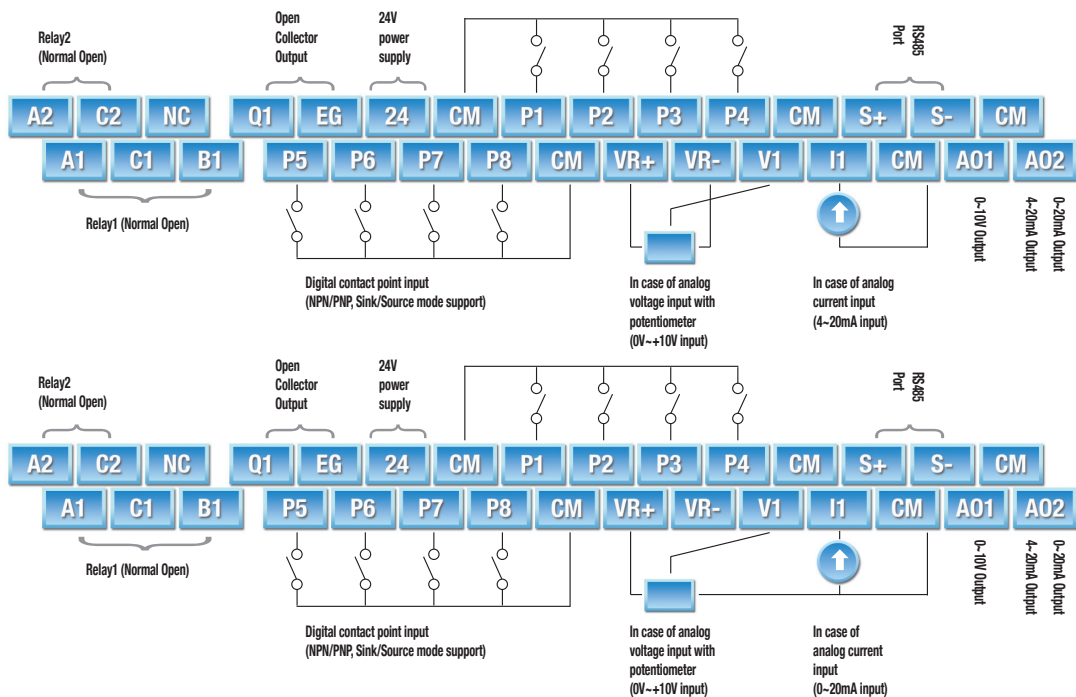

TR terminal located on the above the right side of terminal block is for the terminal resistor of RS485 communication(120Ω)



Peripheral Devices

AC Reactor Specifications

Capacity of Drive	Specifications of the AC reactor			
	Heavy Duty		Normal Duty	
	mH	A	mH	A
0008iS7-2	2.13	5.7	1.20	10
0015iS7-2	1.20	10	0.88	14
0022iS7-2	0.88	14	0.56	20
0037iS7-2	0.56	20	0.39	30
0055iS7-2	0.39	30	0.28	40
0075iS7-2	0.28	40	0.20	59
0110iS7-2	0.20	59	0.15	75
0150iS7-2	0.15	75	0.12	96
0185iS7-2	0.12	96	0.10	112
0220iS7-2	0.10	112	0.07	160
0300iS7-2	0.07	160	0.05	200
0370iS7-2	0.05	200	0.044	240
0450iS7-2	0.044	240	0.038	280
0550iS7-2	0.038	280	0.026	360
0750iS7-2	0.026	360	0.02	500
0008iS7-4	8.63	2.8	4.81	4.8
0015iS7-4	4.81	4.8	3.23	7.5
0022iS7-4	3.23	7.5	2.34	10
0037iS7-4	2.34	10	1.22	15
0055iS7-4	1.22	15	1.14	20
0075iS7-4	1.14	20	0.81	30
0110iS7-4	0.81	30	0.61	38
0150iS7-4	0.61	38	0.45	50
0185iS7-4	0.45	50	0.39	58
0220iS7-4	0.39	58	0.287	80
0300iS7-4	0.287	80	0.232	98
0370iS7-4	0.232	98	0.195	118
0450iS7-4	0.195	118	0.157	142
0550iS7-4	0.157	142	0.122	196
0750iS7-4	0.122	196	0.096	237
0900iS7-4	0.096	237	0.081	289
1100iS7-4	0.081	289	0.069	341
1320iS7-4	0.069	341	0.057	420
1600iS7-4	0.057	420	0.042	558
1850iS7-4	0.042	558	0.042	558
2200iS7-4	0.042	558	0.029	799
2800iS7-4	0.029	799	0.029	799
3150iS7-4	0.029	799	0.024	952
3750iS7-4	0.024	952	0.024	952

DC Reactor Specifications

Capacity of Drive	Specifications of the DC reactor	
	mH	A
0300iS7-2	0.24	200
0370iS7-2	0.2	240
0450iS7-2	0.17	280
0550iS7-2	0.12	360
0750iS7-2	0.1	500

Capacity of Drive	Specifications of the DC reactor	
	mH	A
2800iS7-4	0.09	836
3150iS7-4	0.076	996
3750iS7-4	0.064	1195

Peripheral Devices

Dynamic Braking Unit

UL form	Type	Voltage	Capacity of applied motor	Braking unit	Braking unit
UL type	Type A	200V	30 ~ 37kW	SV370DBU-2U	Refer to the appearance of Group 1
			45 ~ 55kW	SV550DBU-2U	
			75kW	SV370DBU-2U, 2Set	
		400V	30 ~ 37kW	SV370DBU-4U	
			45 ~ 55kW	SV550DBU-4U	
			75kW	SV750DBU-4U	
			90kW	SV550DBU-4U, 2Set	
			110 ~ 132kW	SV750DBU-4U, 2Set	
			160kW	SV750DBU-4U, 3Set	
Non UL type	Type A	200V	30 ~ 37kW	SV037DBH-2	Refer to the appearance of Group 2
		400V	30 ~ 37kW	SV037DBH-4	
			45 ~ 55kW, 75kW	SV075DBH-4	
			185 ~ 220kW	SV2200DB-4 ^{*1)}	Refer to the appearance of Group 4
		280 ~ 375kW	SV2200DB-4, 2Set		
		200V	30 ~ 37kW	LSLV0370DBU-2LN	Group 5
			45 ~ 55kW, 75kW	LSLV0370DBU-2HN	Group 6
				LSLV0750DBU-2LN	Group 5
			LSLV0750DBU-2HN	Group 6	
		400V	30 ~ 37kW	LSLV0370DBU-4LN	Group 5
			45 ~ 55kW, 75kW	LSLV0370DBU-4HN	Group 6
				LSLV0750DBU-4LN	Group 5
			90kW	LSLV0900DBU-4HN	Group 6
			110 ~ 132kW	LSLV1320DBU-4HN	
			160kW	LSLV1600DBU-4HN	
			185 ~ 220kW	LSLV2200DBU-4HN	
			280 ~ 375kW	LSLV2200DBU-4HN, 2Set	

*1) It is not necessary to option type dynamic braking unit for IS7 0.75~22kW(200V, 400V) because basically the dynamic braking unit is built in.

*2) You must refer to dynamic braking unit manual for usage recommended dynamic braking unit in the table above due to changeable table.

*3) Resistance/watt/breaking torque/%ED of DB Resistor for Type A DB Unit refer to the table of "6)DB Resistors". And in case of Type B&C refer to the manual of DB Unit.

* Please refer to the manual for dimensions of DB Unit.



Peripheral Devices

Terminal arrangement

Group 1



Group 2



Group 3

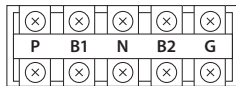

Group 4

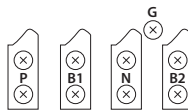

Group 5

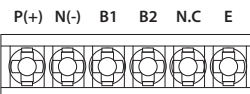

Group 6

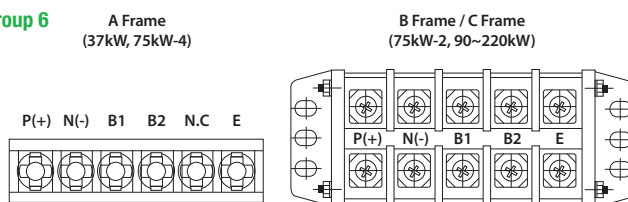

Terminal	Function
G	Ground Terminal
B2	Terminal for connection with B2 of DBU
B1	Terminal for connection with B1 of DBU
N	Terminal for connection with N of Drive
P	Terminal for connection with P1 of Drive

*Note: READ DBU User manual certainly when selecting DB resistors.

Terminal	Function
P	Terminal for connection with P of Drive
B1	Terminal for connection with B1 of DBU
N	Terminal for connection with N of Drive
B2	Terminal for connection with B2 of DBU
G	Ground Terminal

Terminal	Functions
P(+)	Terminal for connection with P of Drive
N(-)	Terminal for connection with N of Drive
B1	Terminal for connection with B1 of DBU
B2	Terminal for connection with B2 of DBU
N.C	Unused
E	Ground Terminal

Terminal	Functions
P(+)	Terminal for connection with P of Drive
N(-)	Terminal for connection with N of Drive
B1	Terminal for connection with B1 of DBU
B2	Terminal for connection with B2 of DBU
N.C	Unused
E	Ground Terminal

Dynamic Braking Unit (DBU) & DB Resistor wiring layout

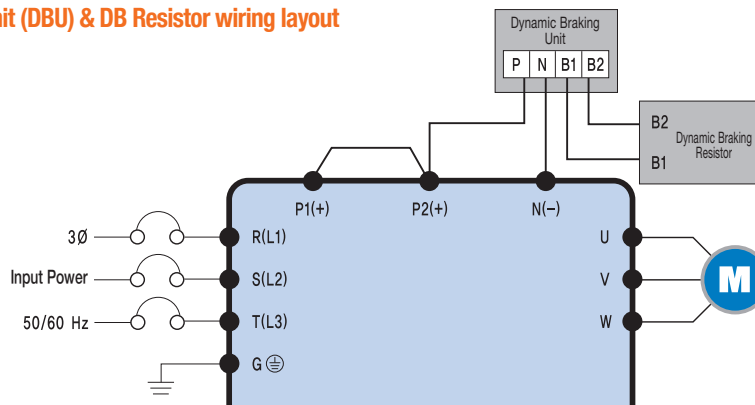

DBU Terminals	Description
B1, B2	Wire correctly referring to diagram. DB Resistors connect with B1,B2 of DB Unit

Peripheral Devices

Dynamic Braking Resistor (Option)

Resistance/watt/braking torque/%ED of DB Resistor for Type A DB Unit refer to the table of "6) DB Resistors".
And in case of Type B&C refer to the manual of Unit. Rating Watt of DBU has to be doubled when %ED is doubled.

Voltage	Applied Drive Capacity (kW)	Apply DB Unit	Format	Resistance [ohm]	Watt [W]	Appearance	Reference	Wiring [mm ²]
200V Class	0.75		-	150	150	TYPE 1	150% braking torque, 5%ED	1.25
	1.5		-	60	300	TYPE 1		1.25
	2.2		MCRB400W50	50	400	TYPE 1		2
	3.7		MCRB600W33	33	600	TYPE 2		3.5
	5.5		MCRM800W20	20	800	TYPE 3		6.63
	7.5		MCRM1200W15	15	1,200	TYPE 3		6.63
	11		MCRM2400W10	10	2,400	TYPE 3		13.3
	15		MCRM2400W8	8	2,400	TYPE 3		13.3
	18.5		MCRM3600W5	5	3,600	TYPE 3		13.3
	22		MCRM3600W5	5	3,600	TYPE 3	13.3	
	30		-	5	5,000	-	100% braking torque, 10%ED	-
	37	SV0370DBU-2U	-	4.5	7,000	-		-
	45		-	3.5	10,000	-		-
	55	SV0550DBU-2U	-	3.0	15,000	-		-
75		-	2.5	20,000	-	-		
400V Class	0.75		-	600	150	TYPE 1	150% braking torque, 5%ED	1.25
	1.5		-	300	300	TYPE 1		2
	2.2		MCRB400W200	200	400	TYPE 1		2
	3.7		MCRB600W130	130	600	TYPE 2		2
	5.5		MCRM1000W85	85	1,000	TYPE 3		2.62
	7.5		MCRM1200W60	60	1,200	TYPE 3		2.62
	11		MCRM2000W40	40	2,000	TYPE 3		13.3
	15		MCRM2400W30	30	2,400	TYPE 3		13.3
	18.5		MCRM3600W20	20	3,600	TYPE 3		13.3
	22		MCRM3600W20	20	3,600	TYPE 3	13.3	
	30		-	16.9	6,400		100% braking torque, 10%ED	-
	37	SV0370DBU-4U	-	16.9	6,400			-
	45		-	11.4	9,600			-
	55	SV0550DBU-4U	-	11.4	9,600			-
	75	SV0750DBU-4U	-	8.4	12,800			-
	90		-	4.5	15,000			-
	110		-	3.5	17,000			-
	132		-	3.0	20,000			-
	160		-	2.5	25,000			-
	185		-	2	30,000			-
220		-	2	30,000		-		
280		-	1.5	40,000		-		
315		-	1	60,000		-		
375		-	1	60,000		-		

Please refer the following if you use option type dynamic braking unit to IS7.

- 1) If you use the DB Unit in parallel, the combined resistance value must be the resistance value in the table above.
- 2) If the braking resistor type name is not listed in the table above, purchase separately a braking resistor reference to resistance and wattage in the table above.

* Please refer to the manual for dimensions of DB Resistor.



Peripheral Devices

Specifications of Wiring switch and Electronic contactor

Drive capacity	Wiring switch				Short circuit switch		Electronic contactor	
	METASOL		SUSOL		Model	Rated Current [A]	Model	Rated Current [A]
	Model	Rated Current [A]	Model	Rated Current [A]				
0008iS7-2	ABS33c	15	UTE100	15	EBS33c	15	MC-9b	11
0015iS7-2	ABS33c	15	UTE100	15	EBS33c	15	MC-12b	12
0022iS7-2	ABS33c	30	UTE100	30	EBS33c	30	MC-18b	18
0037iS7-2	ABS33c	30	UTE100	30	EBS33c	30	MC-32a	32
0055iS7-2	ABS53c	50	UTE150	50	EBS53c	50	MC-40a	40
0075iS7-2	ABS63c	60	UTE150	60	EBS63c	60	MC-50a	55
0110iS7-2	ABS103c	100	UTE150	100	EBS103c	100	MC-65a	65
0150iS7-2	ABS103c	125	UTE150	125	EBS103c	125	MC-100a	105
0185iS7-2	ABS203c	150	UTE150	150	EBS203c	150	MC-130a	130
0220iS7-2	ABS203c	175	UTE250	175	EBS203c	175	MC-150a	150
0300iS7-2	ABS203c	225	UTE250	225	EBS203c	225	MC-150a	150
0370iS7-2	ABS403c	300	UTE400	300	EBS403c	300	MC-225a	225
0450iS7-2	ABS403c	350	UTE400	350	EBS403c	350	MC-330a	330
0550iS7-2	ABS603c	500	UTE600	500	EBS603c	500	MC-400a	400
0750iS7-2	ABS603c	630	UTE600	600	EBS603c	630	MC-630a	630
0008iS7-4	ABS33c	15	UTE100	15	EBS33c	15	MC-9b	15
0015iS7-4	ABS33c	15	UTE100	15	EBS33c	15	MC-9b	15
0022iS7-4	ABS33c	15	UTE100	15	EBS33c	15	MC-12b	15
0037iS7-4	ABS33c	15	UTE100	15	EBS33c	15	MC-18b	15
0055iS7-4	ABS33c	30	UTE100	30	EBS33c	30	MC-22b	30
0075iS7-4	ABS33c	30	UTE100	30	EBS33c	30	MC-32a	30
0110iS7-4	ABS53c	50	UTE150	50	EBS53c	50	MC-40a	50
0150iS7-4	ABS63c	60	UTE150	60	EBS63c	60	MC-50a	60
0185iS7-4	ABS103c	80	UTE150	80	EBS103c	80	MC-65a	80
0220iS7-4	ABS103c	100	UTE150	100	EBS103c	100	MC-65a	100
0300iS7-4	ABS103c	125	UTE150	125	EBS203c	125	MC-100a	125
0370iS7-4	ABS203c	150	UTE150	150	EBS203c	150	MC-130a	150
0450iS7-4	ABS203c	175	UTE250	175	EBS203c	175	MC-150a	175
0550iS7-4	ABS203c	225	UTE250	225	EBS203c	225	MC-185a	225
0750iS7-4	ABS403c	300	UTE400	300	EBS403c	300	MC-225a	300
0900iS7-4	ABS403c	400	UTE400	400	EBS403c	400	MC-330a	400
1100iS7-4	ABS603c	500	UTE600	500	EBS603c	500	MC-400a	500
1320iS7-4	ABS603c	630	UTE600	600	EBS603c	630	MC-400a	600
1600iS7-4	ABS603c	630	UTE600	600	EBS603c	630	MC-630a	600
1850iS7-4	ABS803c	800	UTE800	800	EBS803c	800	MC-630a	800
2200iS7-4	ABS803c	800	UTE800	800	EBS803c	800	MC-800a	800
2800iS7-4	ABS1003b	1000	UTE1200	1000	EBS1003c	1000	1000A	1000
3150iS7-4	ABS1203b	1200	UTE1200	1200	EBS1203c	1200	1200A	1200
3750iS7-4	1400A	1400	1400A	1400	1400A	1400	1400A	1400

Option Slot #1) Fieldbus options

▶ Profibus-DP Card

- Profibus dedicated connector
- Max. 12Mbps communication speed
- Max. 32 stations per segment
- Bus topology
- Enhanced on-line diagnosis



▶ DeviceNet

- Communication speed: 125kbps, 250kbps, 500kbps
- Free/Bus topology
- Max. 64 node connection points
- Max. 500m (1640 ft.) transmission distance (125kbps)



▶ CanOpen Card

- 1Mbps communication speed
- Bus Topology
- Max. 64 node connection points (include master)
- PDO, SDO, Sync, NMC communication support
- Support profile: PDO1 (CiA402 drive & motion control device profile), PDO3 (LS Profile)



▶ CC-Link Card

- 10Mbps communication speed
- Connecting up to 42 AC drives
- Station type: Remote device station
- 1 connection point for 1 AC drive



▶ Ethernet Card

- Modbus TCP, Ethernet IP Protocol support
- 10Mbps, 100Mbps communication speed
- Half duplex, full duplex support
- Auto negotiation
- Max. 100m(328ft.) transmission distance
- CSMA/CD communication access method



▶ LonWorks

- 78kbps communication speed
- Free/bus topology
- Resistance built-in per topology
- Max. 2700m (8858 ft.) connection distance (bus topology)



▶ R-Net/F-Net Card

- 1Mbps Communication speed
- Manchester Biphas-L Frame synchronization
- Max. 64 node connection points
- Max. 750m transmission distance (segment each)



▶ RAPIEnet Card

- RAPIEnet Protocol support
- 100Mbps communication speed
- Full Duplex support
- High speed link(8 WORD), P2P(2 WORD) support
- Max. 64 connection points
- Topology: Line/Ring topology



▶ PROFINet Card

- PROFINet Protocol support PROFINet IO CC-A
- 100Mbps communication speed
- Full Duplex support
- PROFIdrive Class 1
- Max. 64 connection points
- Topology: Line topology



▶ CC-LINK IE Field Card

- CC-LINK IE Field Protocol support
- 1Gbps Transmission speed
- Intelligent device station
- Max, number of stations: 120
- RX/Y 32bits, RWr/w 8words support
- Ring/Line/Star topology





Option Slot #2) PLC/Extension Options

▶ PLC Card

- Master-K 120S platform
- Normal input 6 points (Sink/Source selectable), Max. input 14 points when expanded
- Normal output 4 points (N.O. Relay), Max. output 7 points when expanded
- RTC (Real Time Clock)
- KGL WIN operating system



▶ I/O Expansion Card

- Insulated I/O 3 points each
- Ext-1 - Analog Input : voltage (-10V~10V) 1 point, current (0~20mV) 1 point
Analog Output : voltage (-10V~10V) 1 point, current (0~20mV) 1 point
Digital Input 3 points / Digital Output (Relay) 3 points
- Ext-2 - Analog Input : 4points (voltage (-10V~10V) & current (0~20mV) selectable)
Analog Output : voltage (-10V~10V) 2 point, current (0~20mV) 2 point
Digital Output (TR) 2 points

Ext-2 is available for Web customized version only

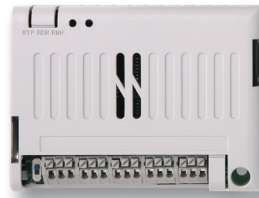

▶ Safety Card

- 2-Channel STO function (STO : Safety Torque Off)
- Safety standard certified

* For 0.75~160kW, Safety option is provided as built-in form from manufacturer.
For 185~375kW, customer can purchase Safety option and install on product by himself.



▶ Synchronization Option Card

- Closed loop control
- 100kHz Max. input frequency
- Position/Speed synchronization
- Synchronization hold (only slave)
- 15 slaves per master(3 serial - 5 parallel max)
- Open collector output : 26V/100mA (2 points)
- Synchronization option card is only available for synchronization version product.



▶ Binary Input Card

- Operating frequency setting with digital input (NPN/PNP)
- Max. 16bit digital input (8bit / 12bit / 16bit)
- Frequency setting with Bias-Gain or BCD
- Frequency resolution (0.01Hz~10Hz)
- Digital input filter function Input signal read timing terminal

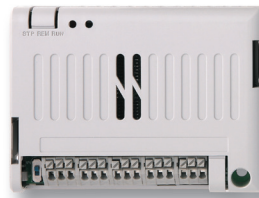

▶ Auxiliary Power Option

- Power supply via external 200~230VAC when main power is off
- 5Vdc power supply to fieldbus cards and control board
- Support fieldbus options (Ret, CANopen, DeviceNet, LonWorks, Profibus-DP, EtherNet, CC-Link, RAPIenet)



Option Slot #3) Encoder Options

▶ Encoder Card

- Closed loop control
- Pulse train reference
- 5/12/15 V insulated power supply
- Line driver or open collector
- 200kHz Max. input frequency
- Signal loss detection



▶ 24V Encoder Card

- Closed loop control
- Pulse train reference
- 24V insulated power supply
- Line driver or open collector
- 200kHz Max. input frequency
- Signal loss detection



▶ Position Control Option Card

- Closed loop control
- Pulse train reference
- 5/12/15V insulated power supply
- Line driver or open collector
- 200kHz Max. input frequency
- Signal loss detection
- External brake control
- Position control option card is only available for synchronization version product.



Marine Certification

■ Marine Certification

Marine classification is that the structure and equipment of the ship has been estimated from the test with the certain standards for certificate issued and given by classification society. SV-IS7 Series is certificated with product testing, process, production equipment and test equipment to install on the shipping.

• DNV(Det Norske Veritas) Marine Certification Details

Certification Institute	DNV (Det Norske Veritas)
Certificate Number	E-11815
Certified Model Types	SV-IS7 series (Range: 0.75kW~75kW, 200V Class / 0.75kW~375kW, 400V Class)
Compliance	Det Norske Veritas' Rules for Classification of Ships, High Speed & Light Craft Det Norske Veritas' Offshore Standards

• BV (Bureau Veritas) Marine Certification Details

Certification Institute	Bureau Veritas (Marine&Off shore Division)
Certificate Number	40183/AO BV
Certified Model Types	SV-IS7 series (Range: 0.75kW~75kW, 200V Class / 0.75kW~375kW, 400V Class)
Compliance	Bureau Veritas Rules for the Classification of Steel Ships

• ABS (American Bureau of Shipping) Marine Certification Details

Certification Institute	ABS (American Bureau of Shipping)
Certificate Number	14-BK1291913-PDA
Certified Model Types	SV-IS7 series (Range: 0.75kW~75kW, 200V Class / 0.75kW~90kW, 400V Class)
Compliance	Installation of the product on an ABS class vessel, MODU or facility

• KR (Korean Resister)

Certification Institute	KR (Korean Resister)
Certificate Number	PTD25585-AC003
Certified Model Types	SV-IS7 series (Range: 0.75 kW~75 kW, 200V / 0.75 kW~375 kW, 400V)
Compliance	Korean Resister's Rules for Classification of Steel Ships



Marine Certification

■ Marine Certification

Voltage	Type	DNV	BV	ABS	KR
3-Phase 200V Class	SV0008iS7-2□□□□V	○	○	○	○
	SV0015iS7-2□□□□V	○	○	○	○
	SV0022iS7-2□□□□V	○	○	○	○
	SV0037iS7-2□□□□V	○	○	○	○
	SV0055iS7-2□□□□V	○	○	○	○
	SV0075iS7-2□□□□V	○	○	○	○
	SV0110iS7-2□□□□V	○	○	○	○
	SV0150iS7-2□□□□V	○	○	○	○
	SV0185iS7-2□□□□V	○	○	○	○
	SV0220iS7-2□□□□V	○	○	○	○
	SV0300iS7-2□□□□V	○	○	○	○
	SV0370iS7-2□□□□V	○	○	○	○
	SV0450iS7-2□□□□V	○	○	○	○
	SV0550iS7-2□□□□V	○	○	○	○
SV0750iS7-2□□□□V	○	○	○	○	
3-Phase 400V Class	SV0008iS7-2□□□□V	○	○	○	○
	SV0015iS7-2□□□□V	○	○	○	○
	SV0022iS7-2□□□□V	○	○	○	○
	SV0037iS7-2□□□□V	○	○	○	○
	SV0055iS7-2□□□□V	○	○	○	○
	SV0075iS7-2□□□□V	○	○	○	○
	SV0110iS7-2□□□□V	○	○	○	○
	SV0150iS7-2□□□□V	○	○	○	○
	SV0185iS7-2□□□□V	○	○	○	○
	SV0220iS7-2□□□□V	○	○	○	○
	SV0300iS7-2□□□□V	○	○	○	○
	SV0370iS7-2□□□□V	○	○	○	○
	SV0450iS7-2□□□□V	○	○	○	○
	SV0550iS7-2□□□□V	○	○	○	○
	SV0750iS7-2□□□□V	○	○	○	○
	SV0900iS7-2□□□□V	○	○	○	○
	SV1100iS7-2□□□□V	○	○	○	○
	SV1320iS7-2□□□□V	○	○	○	○
	SV1600iS7-2□□□□V	○	○	○	○
	SV1850iS7-2□□□□V	○	○	○	○
SV2200iS7-2□□□□V	○	○	○	○	
SV2800iS7-2□□□□V	○	○	○	○	
SV3150iS7-2□□□□V	○	○	○	○	
SV3750iS7-2□□□□V	○	○	○	○	

Dimensions

SV0008 ~ 0037iS7 (200V/400V Class)

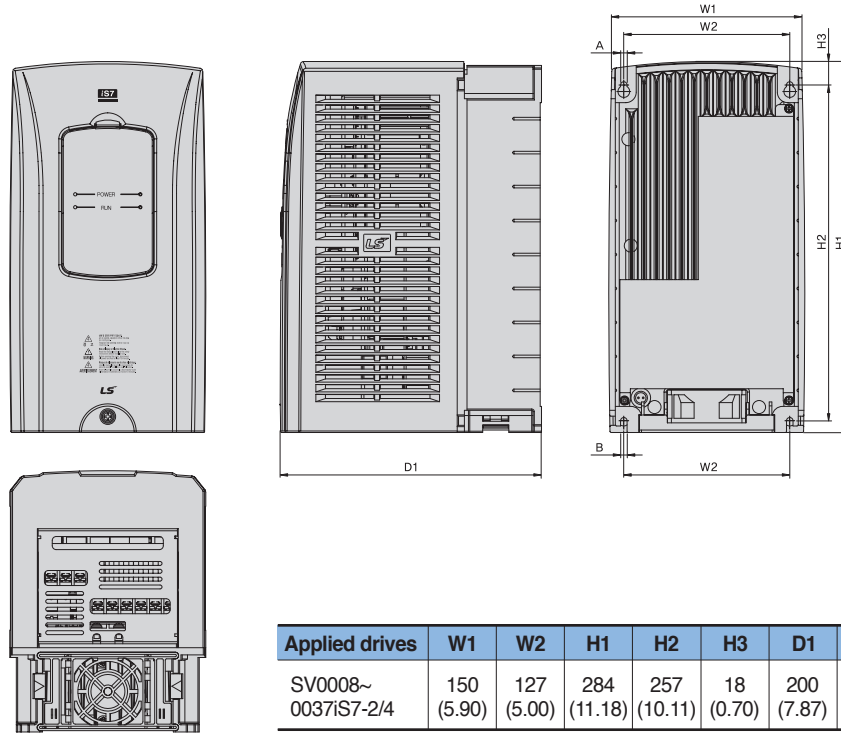

SV0055 ~ 0075iS7 (200V/400V Class)

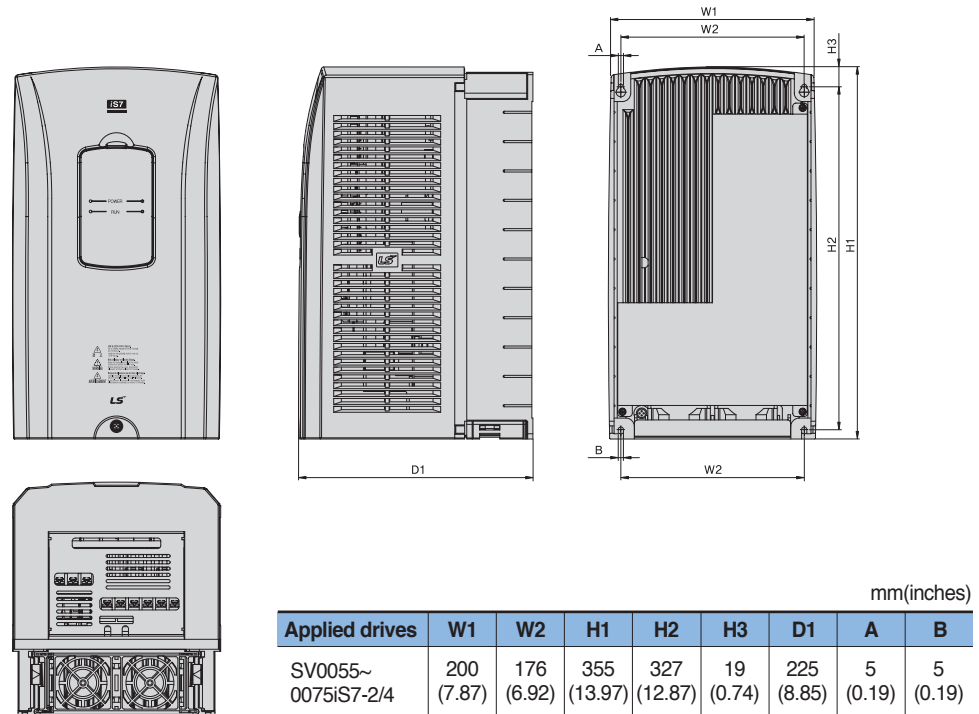



Dimensions

SV0110 ~ 0150iS7 (200V/400V Class)

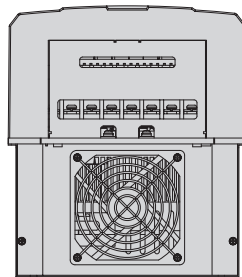
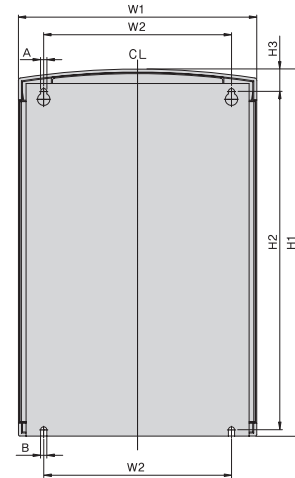
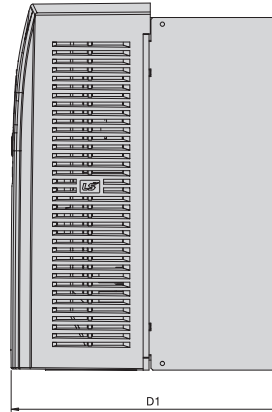
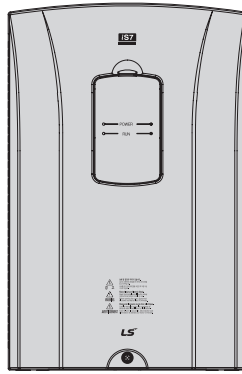

mm(inches)

Applied drives	W1	W2	H1	H2	H3	D1	A	B
SV0110~ 0150iS7-2/4	250 (9.84)	214.6 (8.44)	385 (15.15)	355 (13.97)	23.6 (0.92)	284 (11.18)	6.5 (0.25)	6.5 (0.25)

SV0185 ~ 0220iS7 (200V/400V Class)

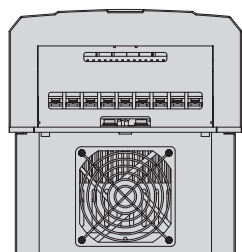
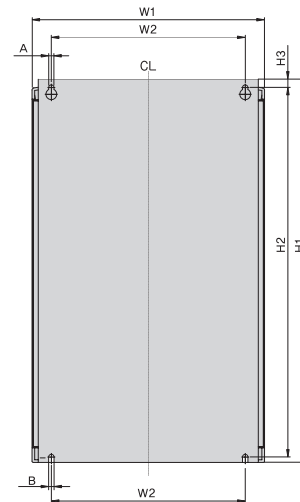
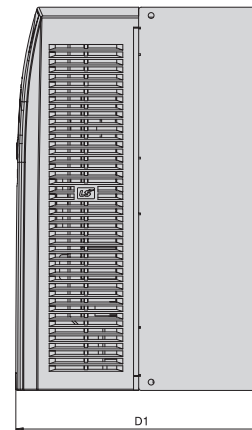

mm(inches)

Applied drives	W1	W2	H1	H2	H3	D1	A	B
SV0185~ 0220iS7-2/4	280 (11.02)	243.5 (9.58)	461.6 (18.17)	445 (17.51)	10.1 (0.39)	298 (11.73)	6.5 (0.25)	6.5 (0.25)

Dimensions

SV0300iS7 (200V Class, IP00 TYPE)

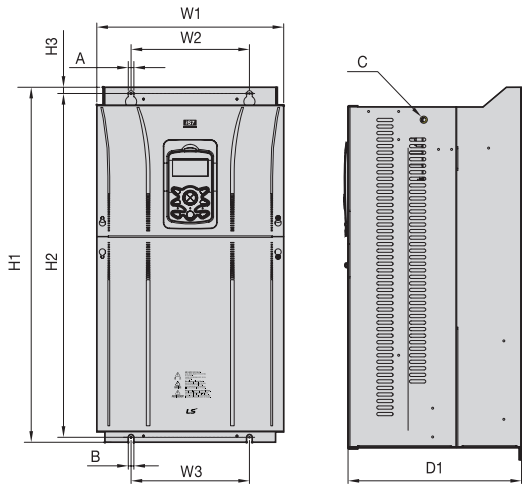

Applied drives	W1	W2/W3	H1	H2	H3	D1	A	B	C
SV0300iS7-2	300 (11.81)	190 (7.48)	570 (22.44)	552 (21.73)	10 (0.39)	265.2 (10.44)	10 (0.39)	10 (0.39)	M8

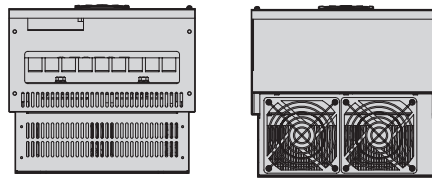

SV0370 ~ 0450iS7 (200V Class, IP00 TYPE)

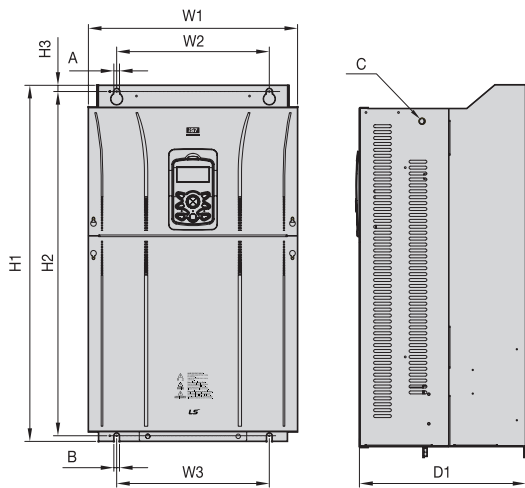

Applied drives	W1	W2/W3	H1	H2	H3	D1	A	B	C
SV0370~ 0450iS7-2	370 (14.56)	270 (10.63)	630 (24.8)	609 (23.97)	11 (0.43)	281.2 (11.07)	10 (0.39)	10 (0.39)	M10

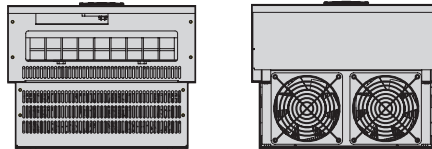

SV0550 ~ 0750iS7 (200V Class, IP00 TYPE)

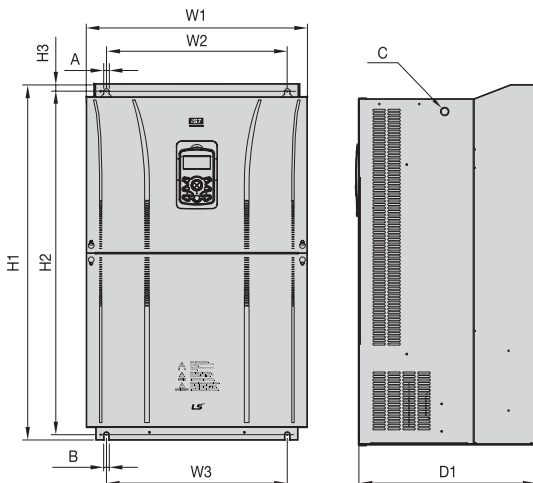

Applied drives	W1	W2/W3	H1	H2	H3	D1	A	B	C
SV0370~ 0450iS7-2	465 (18.3)	381 (15.0)	750 (29.52)	723.5 (28.48)	15.5 (0.61)	355.6 (14.0)	11 (0.43)	11 (0.43)	M16

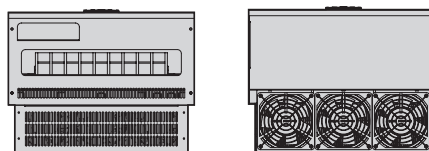



Dimensions

SV0300 ~ 0450iS7 (400V Class)

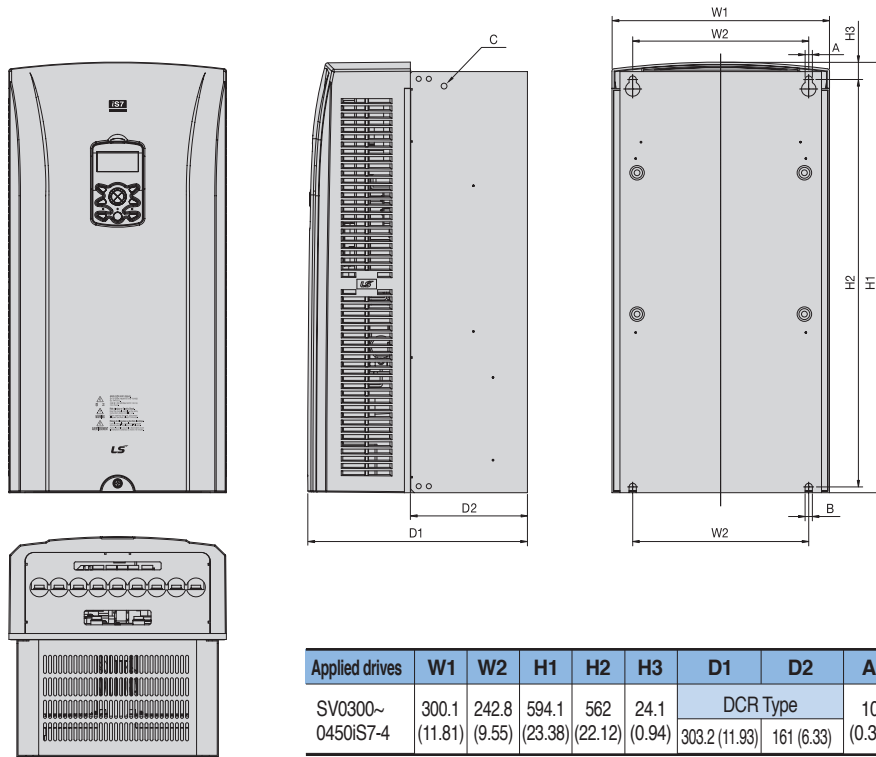

mm(inches)

Applied drives	W1	W2	H1	H2	H3	D1	D2	A	B	C
SV0300~ 0450iS7-4	300.1 (11.81)	242.8 (9.55)	594.1 (23.38)	562 (22.12)	24.1 (0.94)	DCR Type		10 (0.39)	10 (0.39)	M8
						303.2 (11.93)	161 (6.33)			

SV0550 ~ 0750iS7 (400V Class)

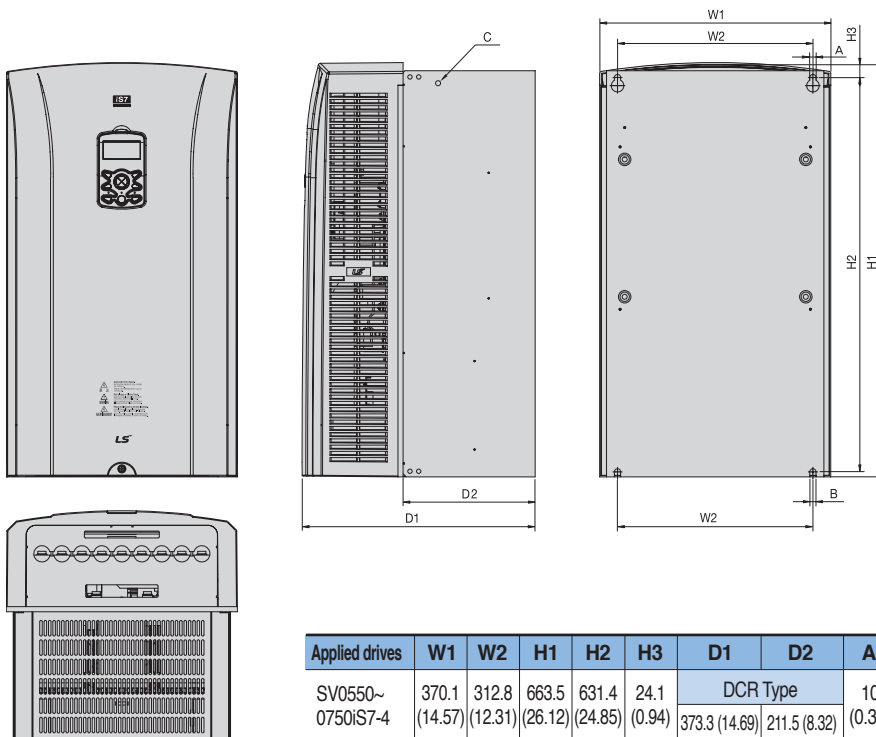

mm(inches)

Applied drives	W1	W2	H1	H2	H3	D1	D2	A	B	C
SV0550~ 0750iS7-4	370.1 (14.57)	312.8 (12.31)	663.5 (26.12)	631.4 (24.85)	24.1 (0.94)	DCR Type		10 (0.39)	10 (0.39)	M8
						373.3 (14.69)	211.5 (8.32)			

Dimensions

SV0900/1100iS7 (400V Class, IP00 TYPE)

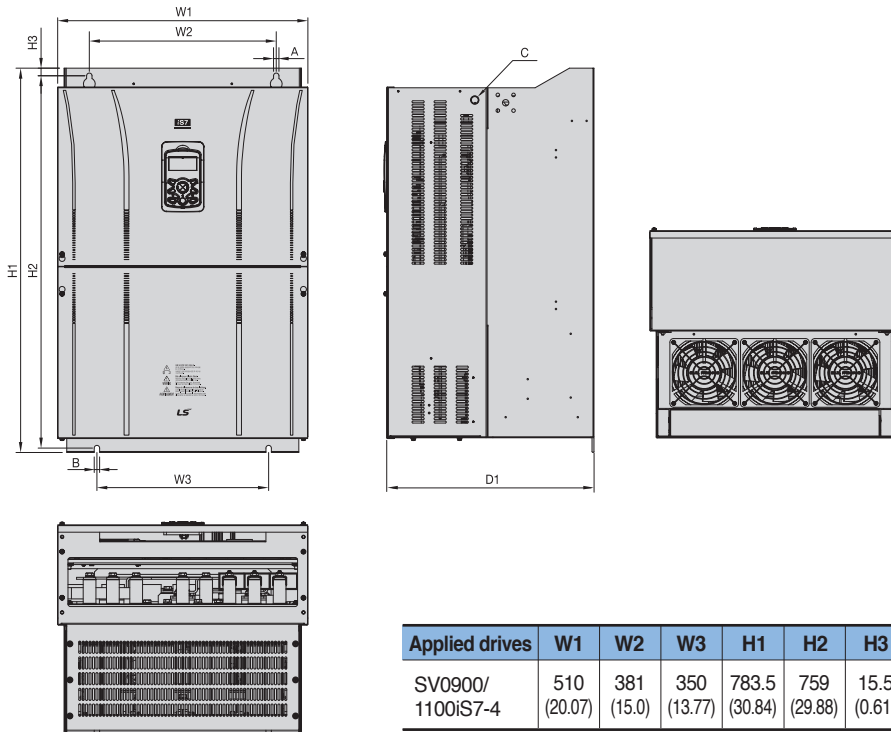

mm(inches)

Applied drives	W1	W2	W3	H1	H2	H3	D1	A	B	C
SV0900/ 1100iS7-4	510 (20.07)	381 (15.0)	350 (13.77)	783.5 (30.84)	759 (29.88)	15.5 (0.61)	422.6 (16.63)	11 (0.43)	11 (0.43)	M16

SV1320/1600iS7 (400V Class, IP00 TYPE)

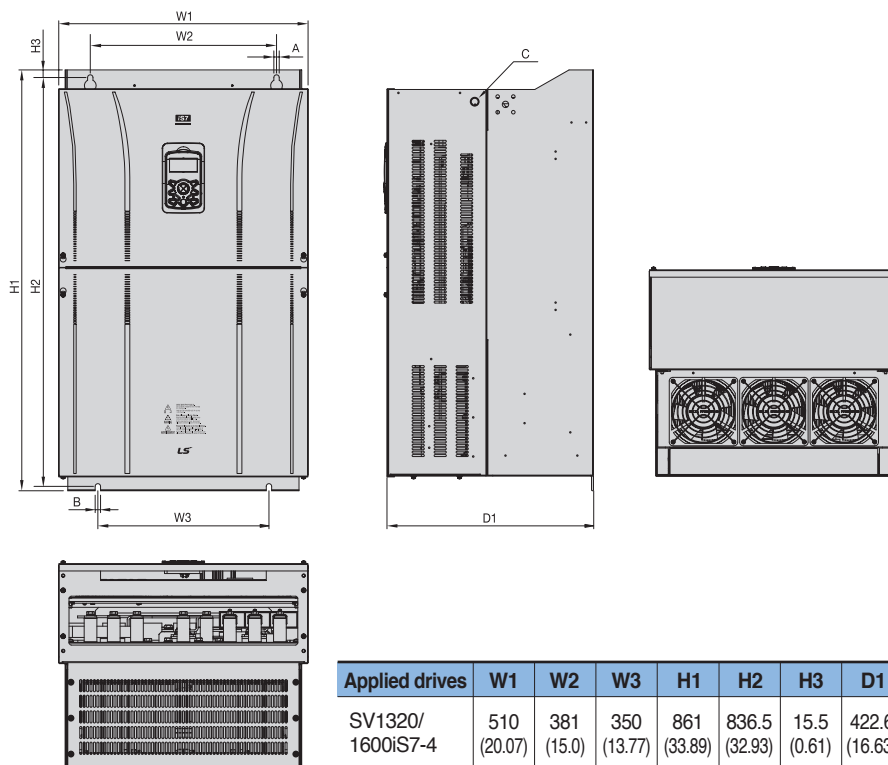

mm(inches)

Applied drives	W1	W2	W3	H1	H2	H3	D1	A	B	C
SV1320/ 1600iS7-4	510 (20.07)	381 (15.0)	350 (13.77)	861 (33.89)	836.5 (32.93)	15.5 (0.61)	422.6 (16.63)	11 (0.43)	11 (0.43)	M16



Dimensions

SV1850/SV2200iS7 (400V Class, IP00 TYPE)

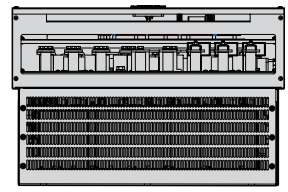
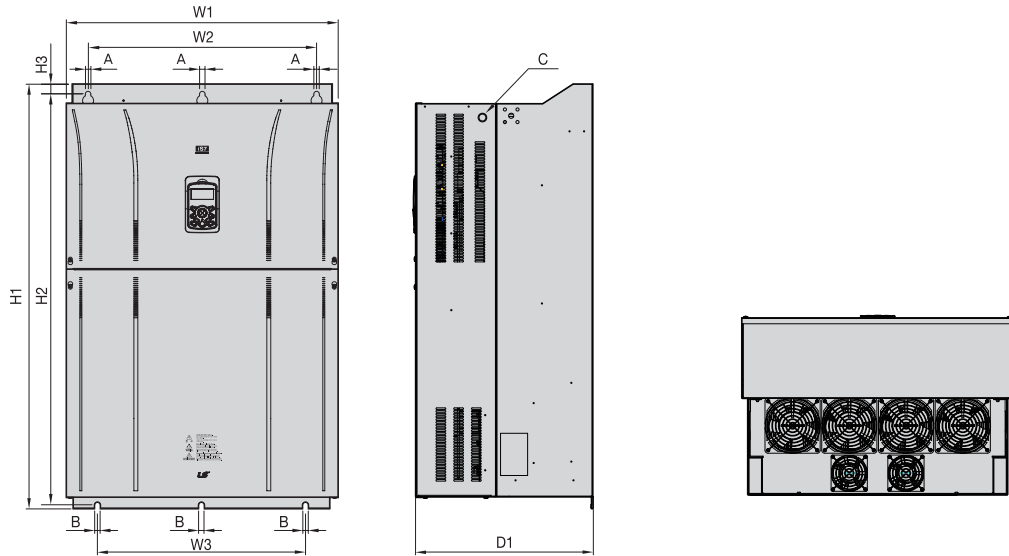

mm(inches)

Applied drives	W1	W2	W3	H1	H2	H3	D1	A	B	C
SV1850/ 2200iS7-4	690 (27.16)	581 (22.87)	528 (20.79)	1078 (42.44)	1043.5 (41.08)	25.5 (1.00)	450 (17.72)	14 (0.55)	15 (0.59)	M20

SV2800iS7 (400V Class, IP00 TYPE)

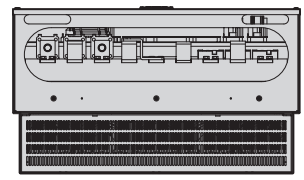
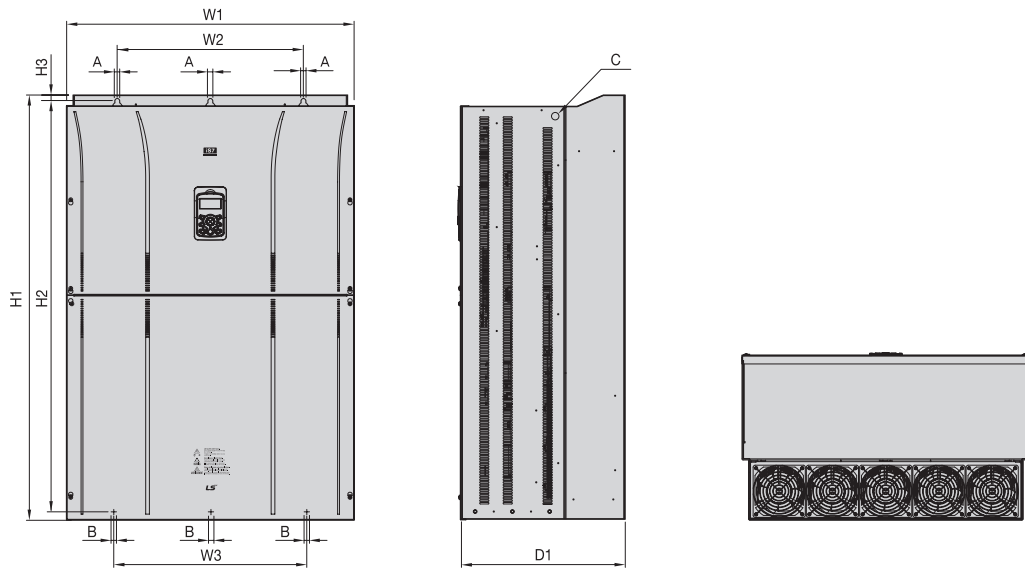

mm(inches)

Applied drives	W1	W2	W3	H1	H2	H3	D1	A	B	C
SV2800iS7-4	771 (30.35)	500 (19.69)	500 (19.69)	1138 (44.80)	1110 (43.70)	15 (0.59)	440 (17.32)	13 (0.51)	13 (0.51)	M16

Dimensions

■ SV3150/3750iS7 (400V Class, IP00 TYPE)

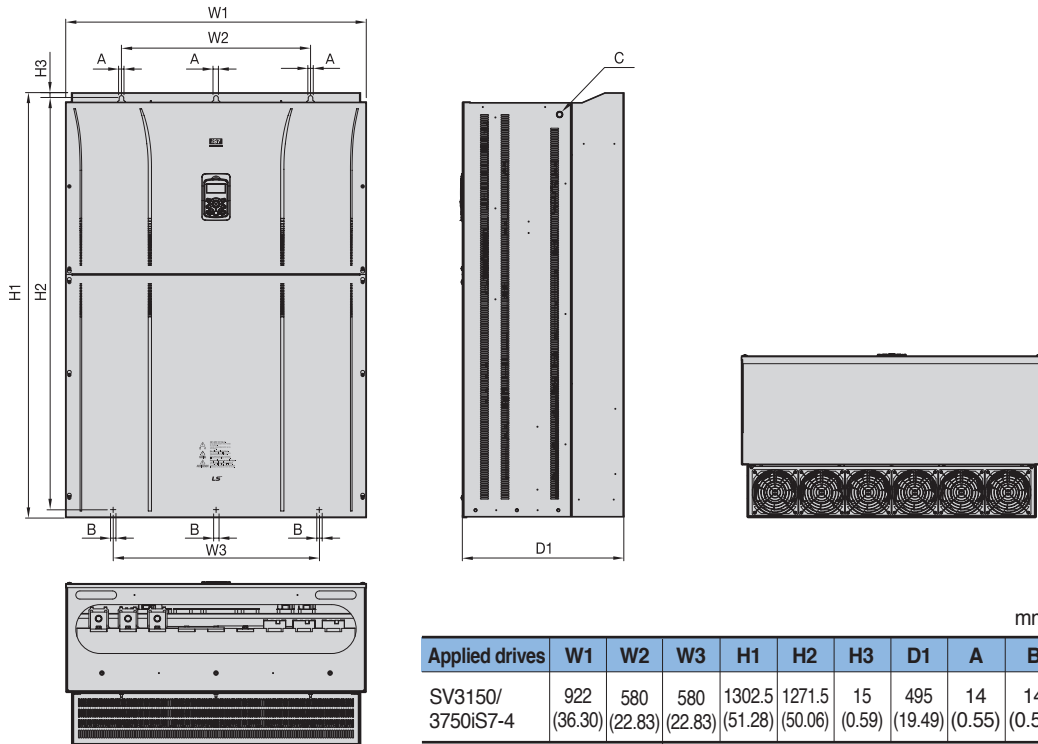



Dimensions (IP54)

SV0008 ~ 0037iS7 (200V/400V Class)

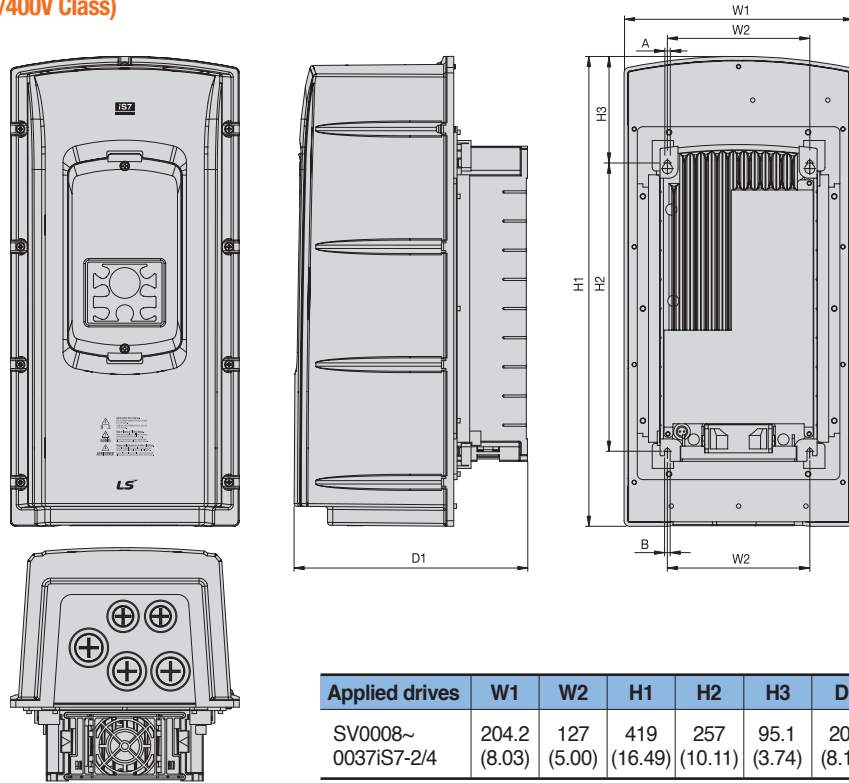

mm(inches)

Applied drives	W1	W2	H1	H2	H3	D1	A	B
SV0008~ 0037iS7-2/4	204.2 (8.03)	127 (5.00)	419 (16.49)	257 (10.11)	95.1 (3.74)	208 (8.18)	5 (0.19)	5 (0.19)

SV0055 ~ 0075iS7 (200V/400V Class)

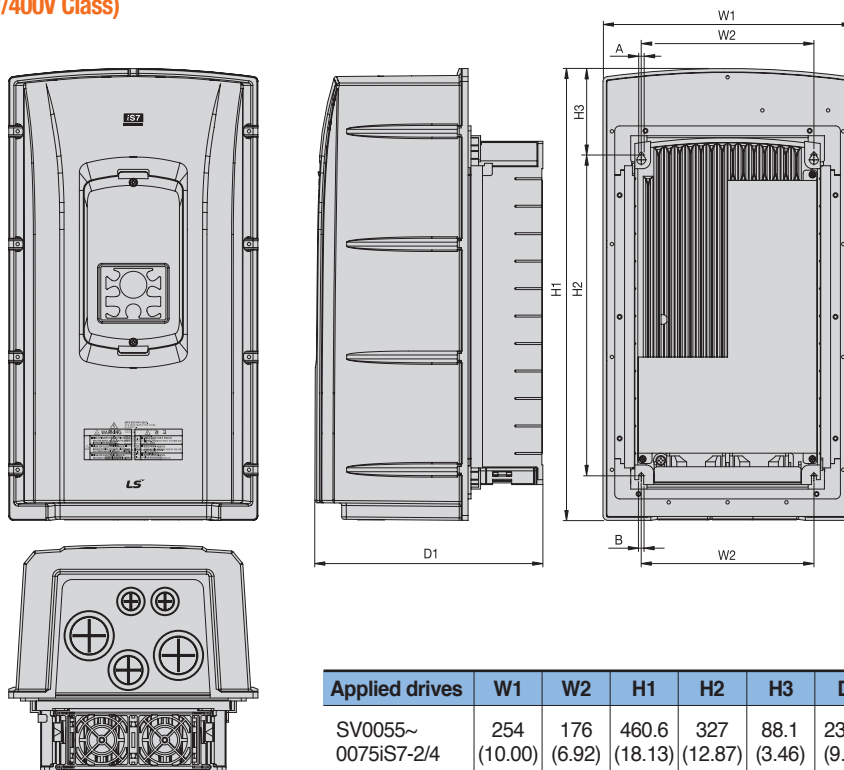

mm(inches)

Applied drives	W1	W2	H1	H2	H3	D1	A	B
SV0055~ 0075iS7-2/4	254 (10.00)	176 (6.92)	460.6 (18.13)	327 (12.87)	88.1 (3.46)	232.3 (9.14)	5 (0.19)	5 (0.19)

Dimensions (IP54)

SV0110 ~ 0150iS7 (200V/400V Class)

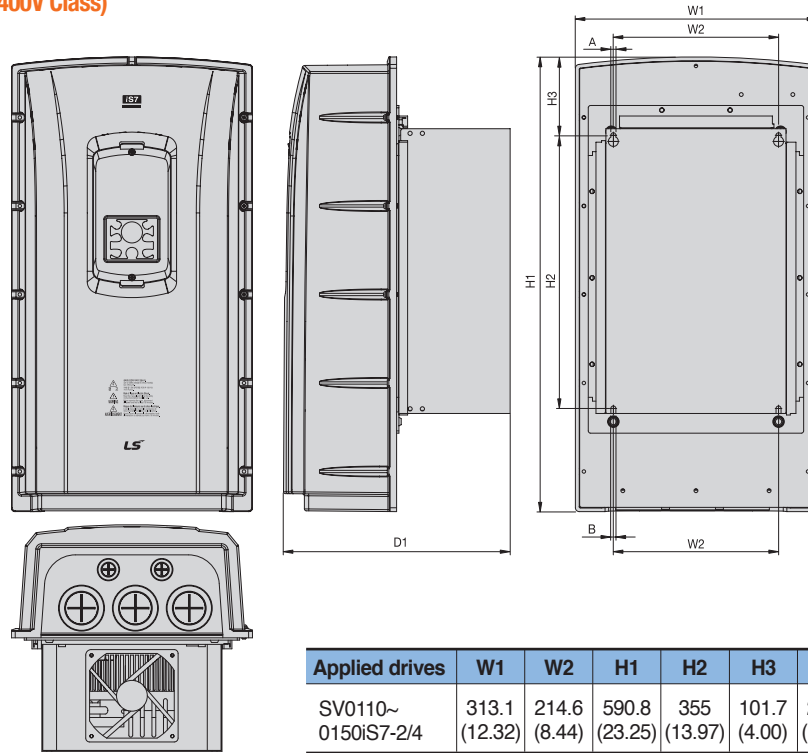

SV0185 ~ 0220iS7 (200V/400V Class)

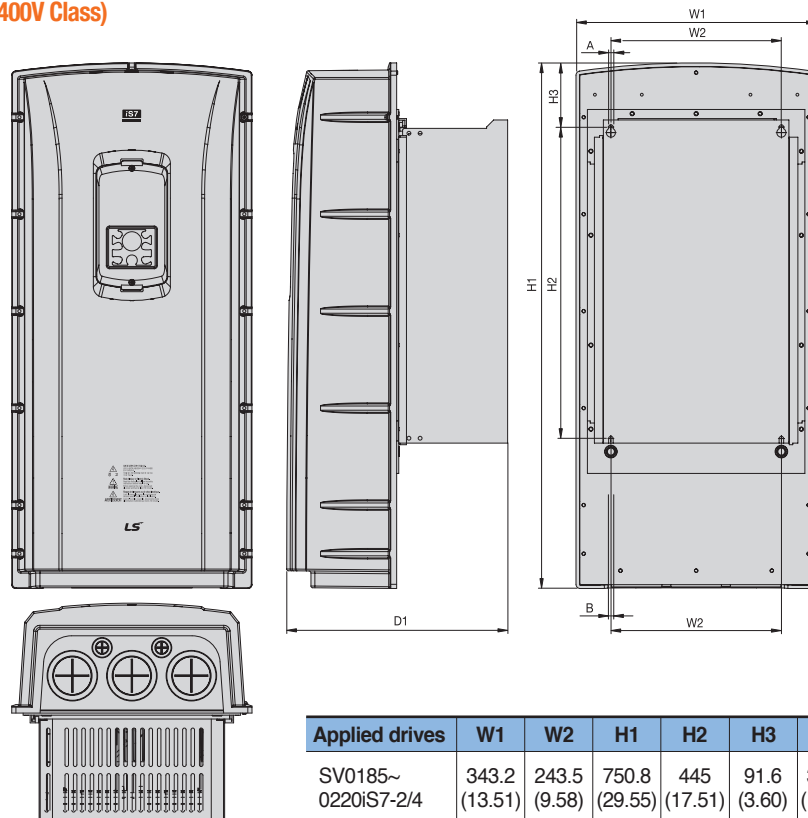



Dimensions (Conduit option)

SV0008 ~ 0037iS7 (200V/400V Class)

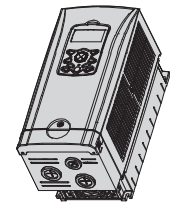
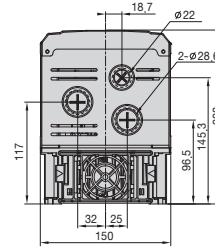
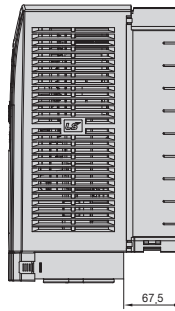
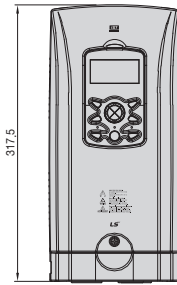

Drive + Conduit Box

SV0055 ~ 0075iS7 (200V/400V Class)

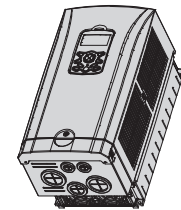
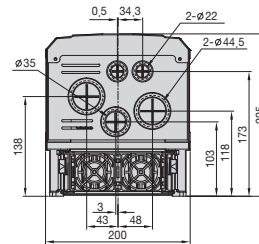
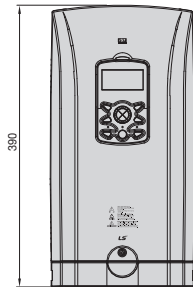

Drive + Conduit Box

SV0110 ~ 0150iS7 (200V/400V Class)

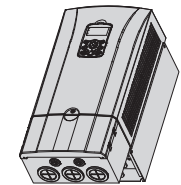
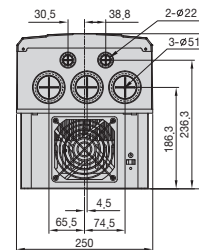
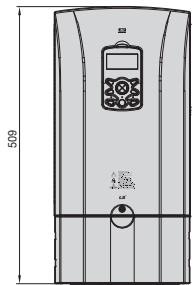

Drive + Conduit Box

SV0185 ~ 0220iS7 (200V Class)

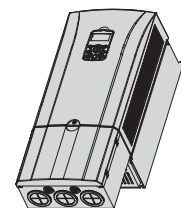
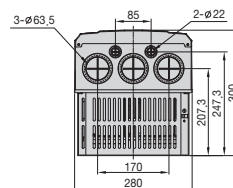
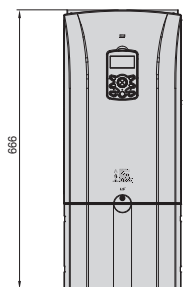

Drive + Conduit Box

Dimensions (Conduit option)

SV0185 ~ 0220iS7 (400V Class)

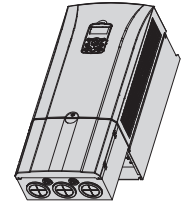
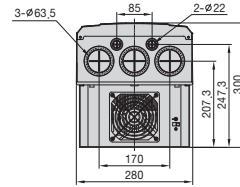
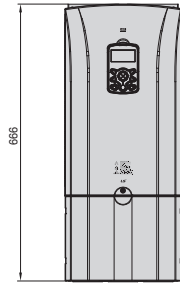

Drive + Conduit Box

SV0300 ~ 0450iS7 (400V Class)

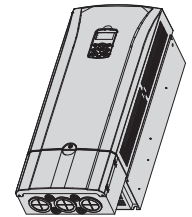
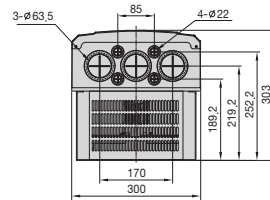
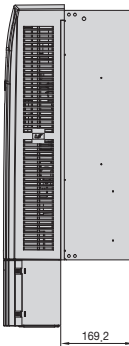
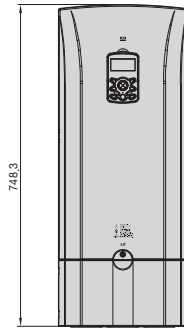

Drive + Conduit Box

SV0550 ~ 0750iS7 (400V Class)

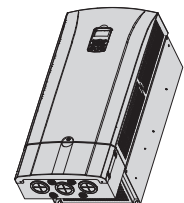
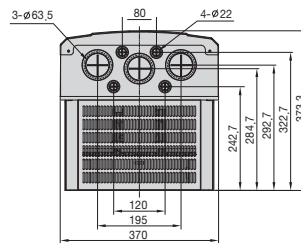
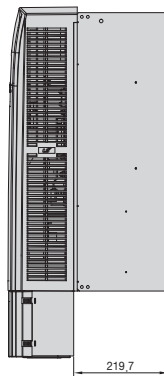
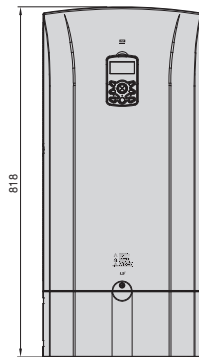

Drive + Conduit Box



Dimensions (Flange option)

SV0008 ~ 0037iS7 (200V/400V Class)

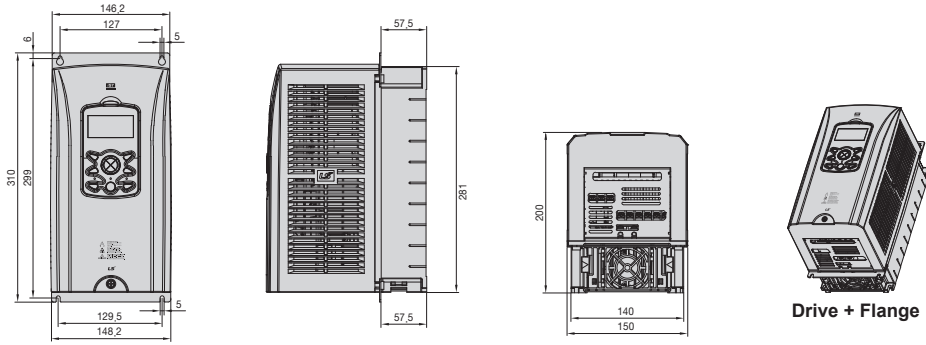

SV0055 ~ 0075iS7 (200V/400V Class)

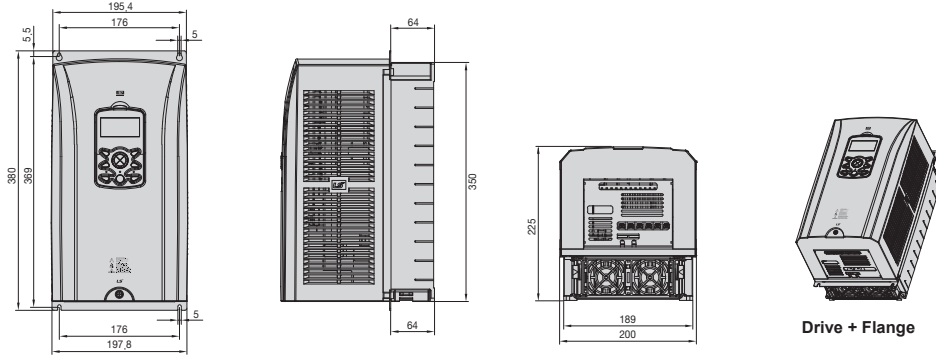

SV0110 ~ 0150iS7 (200V/400V Class)

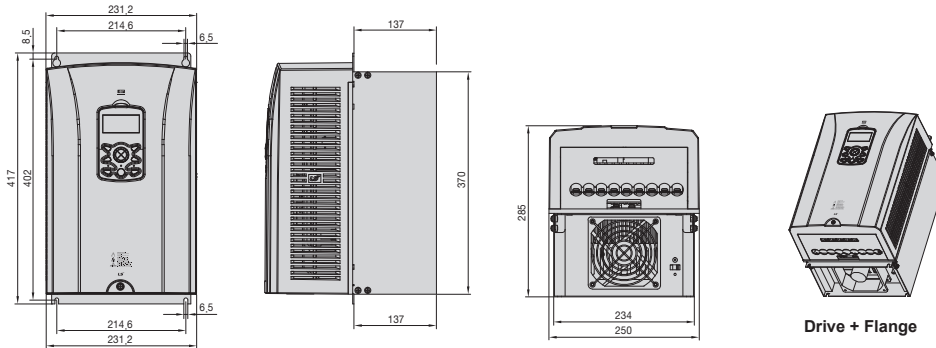

SV0185 ~ 0220iS7 (200V Class)

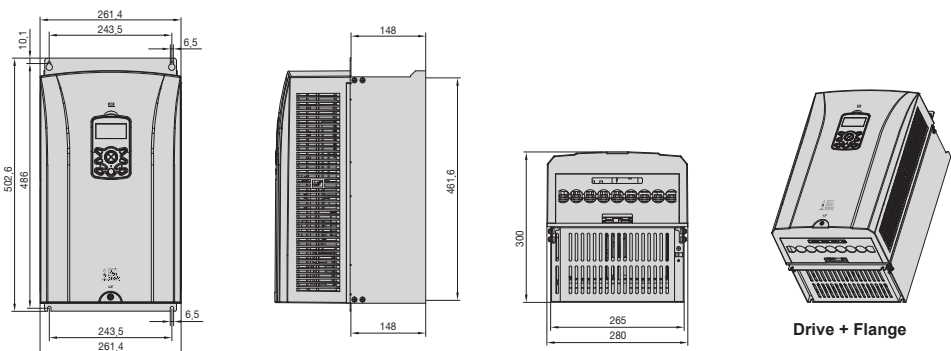

Dimensions (Flange option)

SV0185 ~ 0220iS7 (400V Class)

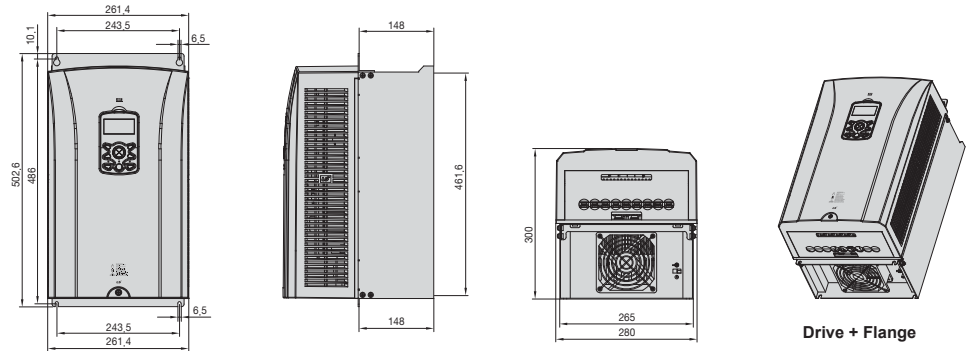

SV0300 ~ 0450iS7 (400V Class)

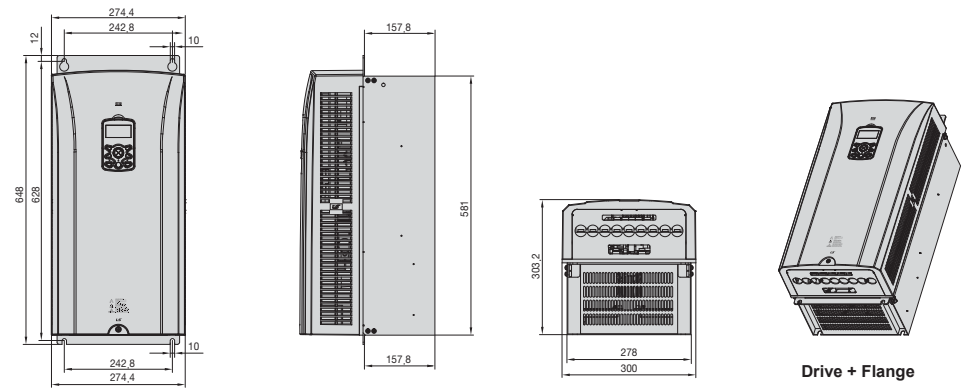

SV0550 ~ 0750iS7 (400V Class)

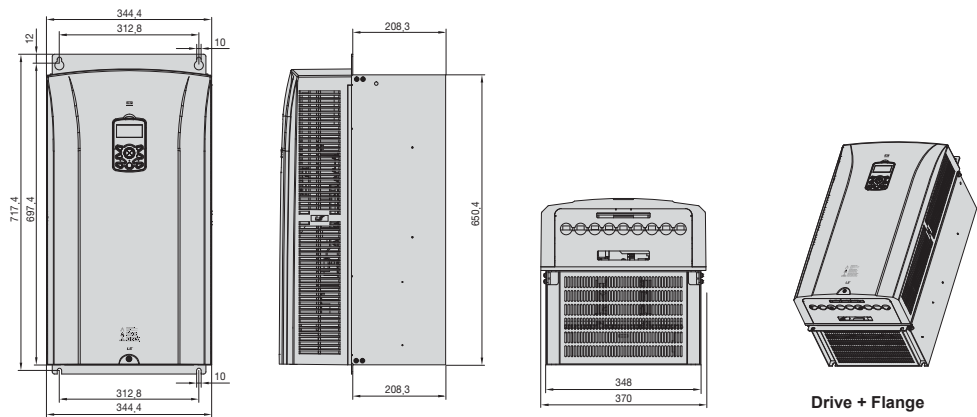



Memo

A large, empty, light blue rounded rectangular area intended for writing a memo.

Memo

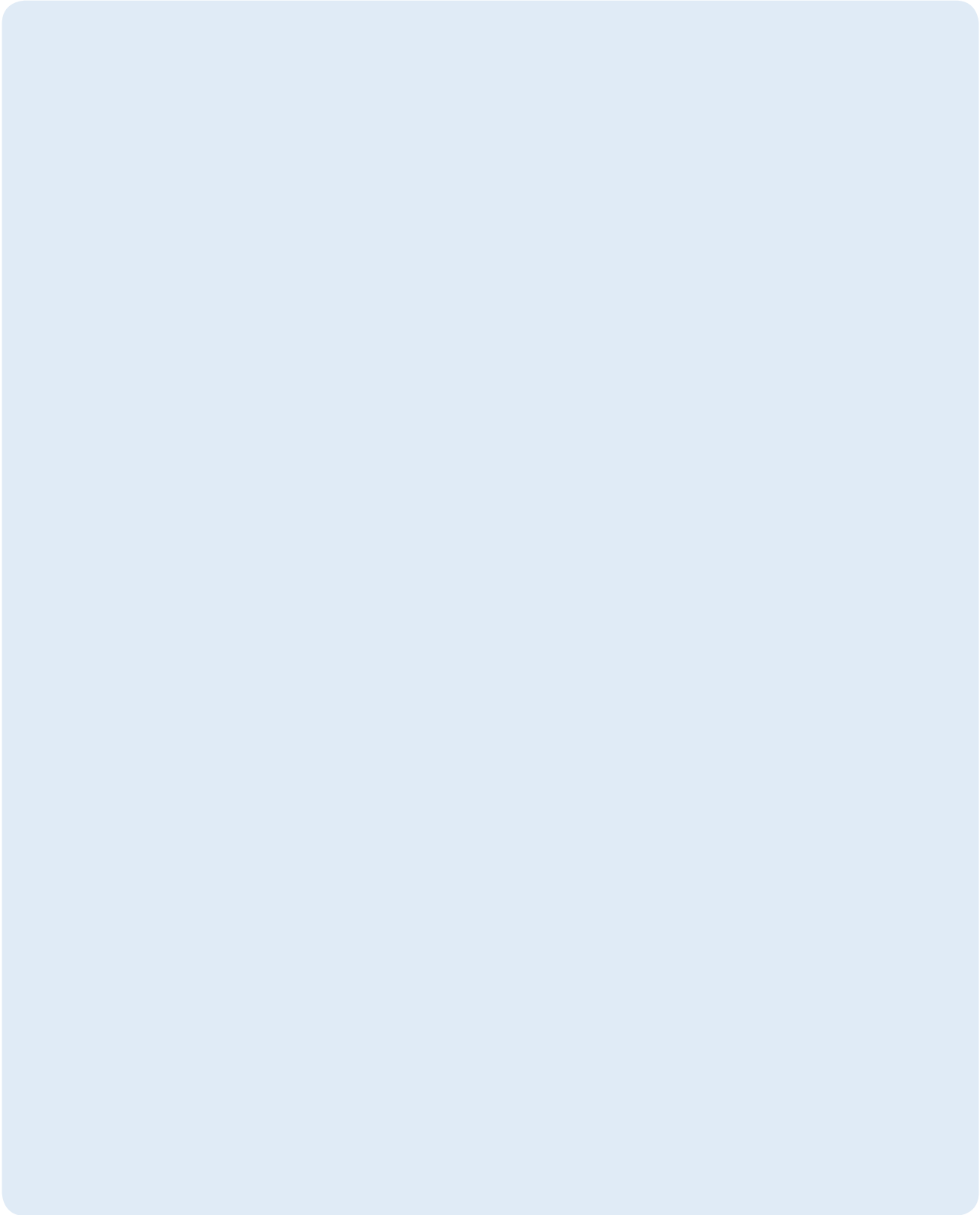



Memo

A large, empty, light blue rectangular area intended for writing a memo.



Safety Instructions

- For your safety, please read user's manual thoroughly before operating.
- Contact the nearest authorized service facility for examination, repair, or adjustment.
- Please contact qualified service technician when you need maintenance.
Do not disassemble or repair by yourself!
- Any maintenance and inspection shall be performed by the personnel having expertise concerned.



www.lsis.com

■ Head Quarter

LS-ro 127(Hogye-dong) Dongan-gu, Anyang-si, Gyeonggi-Do, 14119, Korea
Tel: 82-2-2034-4620 mwoo@lsis.com
Tel: 82-2-2034-4907 hjchoid@lsis.com

■ Overseas Subsidiaries

- **LSIS(Dalian) Co., Ltd. (Dalian, China)**
Tel: 86-411-8730-7510 Fax: 86-411-8730-7560 E-Mail: dskim@lsis.com
- **LSIS(Wuxi) Co., Ltd. (Wuxi, China)**
Tel: 86-510-8534-6666-8005 Fax: 86-510-8534-4078 E-Mail: sojin@lsis.com
- **LS VINA Industrial Systems Co., Ltd. (Hanoi, Vietnam)**
Tel: 84-4-6275-8055 Fax: 84-4-3882-0220 E-Mail: hjchoid@lsis.com
- **LSIS Middle East FZE (Dubai, U.A.E.)**
Tel: 971-4-886-5360 Fax: 971-4-886-5361 E-Mail: shunlee@lsis.com
- **LSIS Europe B.V. (Amsterdam, Netherlands)**
Tel: 31-20-654-1420 Fax: 31-20-654-1429 E-Mail: europartner@lsis.com
- **LSIS Japan Co., Ltd. (Tokyo, Japan)**
Tel: 81-3-6268-8241 Fax: 81-3-6268-8240 E-Mail: jschuna@lsis.com
- **LSIS USA Inc. (Chicago, U.S.A.)**
Tel: 1-800-891-2941 Fax: 1-847-383-6543 E-Mail: sales.us@lsis.com

■ Overseas Branches

- **LSIS Shanghai Office (China)**
Tel: 86-21-5237-9977(609) Fax: 86-21-5237-7189 E-Mail: ygeo@lsis.com
- **LSIS Beijing Office (China)**
Tel: 86-10-5761-3127 Fax: 86-10-5761-3128 E-Mail: htroh@lsis.com
- **LSIS Guangzhou Office (China)**
Tel: 86-20-8326-6784 Fax: 86-20-8326-6287 E-Mail: sojhtroh@lsis.com
- **LSIS Qingdao Office (China)**
Tel: 86-532-8501-6058 Fax: 86-532-8501-6057 E-Mail: htroh@lsis.com
- **LSIS Chengdu Office (China)**
Tel: 86-28-8670-3200 Fax: 86-28-8670-3203 E-Mail: yangcf@lsis.com
- **LSIS ShenYang Office (China)**
Tel: 86-24-2321-9050 Fax: 86-24-8386-7210 E-Mail: yangcf@lsis.com
- **LSIS Jinan Office (China)**
Tel: 86-531-8699-7826 Fax: 86-531-8697-7628 E-Mail: yangcf@lsis.com
- **LSIS Co., Ltd. Tokyo Office (Japan)**
Tel: 81-3-6268-8241 Fax: 81-3-6268-8240 E-Mail: jschuna@lsis.com
- **LSIS Co., Ltd. Rep. Office (Vietnam)**
Tel: 84-8-3823-7890 E-Mail: sjbaik@lsis.com
- **LSIS Moscow Office (Russia)**
Tel: 7-499 682 6130 E-Mail: info@lsis-ru.com
- **LSIS Jakarta Office (Indonesia)**
Tel: 62-21-293-7614 E-Mail: dioh@lsis.com